



The IFR Quick-Review Study Guide

Instrument-Airplane

By Amir Fleminger

CFI, CFII, MEI, ATP, Gold Seal Flight Instructor,
EMB-145, ERJ 170/190, Bsc Professional Aeronautics, MS Aeronautical Science

TABLE OF CONTENTS

PILOT QUALIFICATIONS	3	DEPARTURE.....	7
When is an Instrument rating required?	3	IFR Takeoff minimums.....	7
Logging Instrument Time	3	Departure Procedures (DP).....	7
Minimum Aeronautical Experience (§61.65).....	3	Diverse Departure Procedures	7
Recency of Experience	3	Diverse Vector Area.....	7
IFR Recency Timeline	4	Climb Over Airport (VCOA).....	7
Use of full flight SIM, FTD, or ATD for acquiring instrument aeronautical experience (§61.51)	4	IFR Departure Clearance –“CRAFT”	8
Logging Instrument Approach Procedures – Requirements	4	STANDARD TERMINAL ARRIVAL (STAR)	8
AERONAUTICAL DECISION MAKING	4	CLIMB/DESCENT CLEARANCES	8
Preflight self-assessment – “IM SAFE”	4	CRUISE CLEARANCE	9
Risk Management & Personal Minimums – “PAVE” ..	4	IFR ALTITUDES	9
Decision Making – “DECIDE”	4	FLIGHT INSTRUMENTS.....	10
PERSONAL DOCUMENTS REQUIRED FOR FLIGHT	5	Gyroscopic Instruments.....	10
AIRCRAFT DOCUMENTS REQUIRED FOR FLIGHT – “ARROW”	5	Pitot-Static Instruments	10
AIRCRAFT MAINTENANCE INSPECTIONS REQUIRED FOR IFR – “AVIATES”	5	Airspeed Indicator Markings.....	11
BRIEFINGS	5	V-Speeds	11
Passenger Briefing – “SAFETY”	5	Static Port Blockage	11
Taxi Briefing – “ARCH”	5	Pitot Tube Blockage	11
Takeoff Briefing – “DEPARTS”	5	Generic Instrument Taxi Check	11
PREFLIGHT INFO REQUIRED FOR IFR	6	Magnetic compass errors & limitations – “DV MONA”.....	12
IFR FLIGHT PLAN.....	6	Electronic Flight Instruments	12
IFR MINIMUM FUEL REQUIREMENTS	6	MINIMUM EQUIPMENT REQUIRED FOR FLIGHT...12	
ALTERNATES	6	Operating with inoperative items (§91.213).....	12
Is a destination alternate required? “1-2-3” rule	6	RADIO NAVIGATION	13
Min Weather Conditions required at An alternate.....	6	Standard VOR Service Volumes	13
Filing an alternate - GPS considerations	6	VHF OMNI Directional Range (VOR)	13
IFR CRUISING ALTITUDES.....	6	DME Service Volumes.....	13
		Distance Measuring Equipment (DME)	13

TABLE OF CONTENTS - Continued

Non-Directional Beacon (NDB)	13	WEATHER HAZARDS.....	24
Compass Locator	13	Thunderstorms	24
Instrument Landing System (ILS).....	14	Fog	24
Global Positioning System (GPS)	15	Icing	24
AREA NAVIGATION (RNAV)	15	AEROMEDICAL	25
Required Navigation Performance (RNP)	16	TABLES & REFERENCES	26
ATTITUDE INSTRUMENT FLYING	16	US TERMINAL PROCEDURES PUBLICATIONS LEGEND	28
Required reports under IFR.....	17	Radio aid symbols	28
Position Report Items	17	Airports	28
HOLDING PATTERNS	17	Altitudes.....	28
Make all hold turns:	17	Special Use Airspace	28
Holding pattern timing	17	Terminal Routes	28
Holding Speeds	17	Holding Patterns	28
Holding Entry.....	17	Indicated AIRSPEED.....	28
at the hold fix, report to ATC:.....	17	STAR/DP Routes.....	28
LOST COMMUNICATIONS PROCEDURE.....	18	Miscellaneous.....	29
PROCEDURE TURN.....	18	Terminal Arrival Area (TAA)	29
INSTRUMENT APPROACHES	18	Minimum Safe Altitude (MSA)	29
Visual Descent Point (VDP) (AIM 5-4-5)	19	Planview Obstacles	29
Vertical Descent Angle (VDA) (AIM 5-4-5)	19	Fixes/ATC Reporting Requirements	29
AIRSPACE.....	20	Profile View.....	30
BASIC VFR WEATHER MINIMUMS	20	Approach Light Systems (ALS)	31
Special Use Airspace	21	TERMS & DEFINITIONS.....	34
MAX AIRCRAFT AIRSPEEDS IN THE U.S.....	22		
WEATHER.....	22		
weather information sources	22		
Types of Weather Briefings	22		
weather Products	22		

PILOT QUALIFICATIONS

WHEN IS AN INSTRUMENT RATING REQUIRED?

- When acting as **PIC** under **IFR** or in weather conditions **less than** prescribed for **VFR**. (§61.3)
- When carrying **passengers** for **compensation** or **hire** on **cross-country** flights in excess of **50 NM** or at **night**. (§61.133)
- For flight in **Class A** airspace (§91.135)
- For **Special VFR** between **sunset and sunrise** (§91.157)

MINIMUM AERONAUTICAL EXPERIENCE (§61.65)

- 50 hours X-Country PIC time
 - ▷ Of which, 10 hours in airplanes.
- 40 hours actual or simulated instrument time
 - ▷ Of which, 15 hours with CFII.
 - Including one X-Country flight of:
 - 250 NM along airways or by directed ATC routing.
 - An instrument approach at each airport.
 - 3 different kinds of approaches using navigation systems.
 - With a filed IFR flight plan.
 - 3 Hours instrument flight training in last 2 Calendar months prior to practical test
- Use of approved full flight simulator or FTD, if trained by authorized instructor:
 - ▷ Max. 30 hours if instrument time completed under Part 142
 - ▷ Max 20 hours if not completed under 142
- Use of FAA approved Aviation Training Device, if trained by an authorized instructor:
 - ▷ Max. 10 hours of instrument time if Basic ATD
 - ▷ Max. 20 hours of instrument time if Advanced ATD
- No more than 20 hours of total instrument time can be credited in a full flight simulator, FTD or ATD, except the 30 hours exception under Part 142 mentioned above.

REGENCY OF EXPERIENCE
To act as PIC (§61.56)

A **Flight review** is required since the beginning of the **24 calendar months** before the month of the flight in an aircraft for which the **pilot is rated**. Consists of **minimum 1 hour of flight training** and **1 hour ground training**. Conducted by an **authorized instructor**.

The flight review can be substituted by:

- A **proficiency check** or **practical pilot test** for a **pilot certificate, rating or operating privilege**. (conducted by an approved examiner, pilot check airman, or US Armed Force).
- A **practical test**, conducted by an **examiner**, for **flight instructor certificate, additional rating, renewal or reinstatement**.
- Completion of **one or more phases** of the FAA-sponsored **pilot proficiency award program** (WINGS).
- **Flight instructor renewal** under Part 61.197 exempts the pilot from the **ground portion** of the flight review.

LOGGING INSTRUMENT TIME (§61.51)

A person may log instrument time only for that flight time when the person operates the aircraft solely by reference to instruments under actual or simulated instrument flight conditions.

An authorized instructor may log instrument time when conducting instrument flight instruction in actual instrument flight conditions.

A **Flight simulator or FTD** may be used to meet the **flight review requirements** as long as:

- It is used in an **approved course by a training center under Part 142**.
- **Represent an aircraft for which the pilot is rated.**

To carry passengers as PIC (§61.57)

- **3 takeoffs & landings in category, class and type** (if type rating req.) In the **last 90 days**.
- **At periods between 1 hour after sunset to 1 hour before sunrise:** 3 takeoffs & landings to full stop within 1 hour after sunset to 1 hour before sunrise.
- The takeoffs and landings may be accomplished in a FFS or FTD if it is approved for landings and used in a Part 142 training center.

See exceptions in 61.57(e) for pilots operating under Part 121, 125, 135 and PIC of turbine-powered airplanes with more than one flight crewmember.

To act as PIC under IFR or in weather conditions less than VFR minimums- "6 HITS" – (§61.57(c))

Within the 6 calendar months preceding the month of flight, you performed and logged (in actual or simulated conditions):

- **6 instrument approaches.**
- **Holding procedures & tasks.**
- **Intercepting & Tracking courses** through the use of **navigational electronic systems.**

These tasks can be completed in a FFS, ATD, or FTD provided the device represents the category of aircraft for the instrument rating privileges to be maintained and the pilot performs the tasks and iterations in simulated instrument conditions. A flight instructor is not needed.

No "6 HITS" logged looking back six months?

You have an **additional 6 months to regain currency** by performing the **"6 HITS" with a safety pilot.**

Safety pilot requirements

- ▷ Holds at least a **private pilot** certificate with the appropriate **category and class** and a **valid medical / BasicMed**.
- ▷ Have **adequate vision forward** and to **each side** of the aircraft.
- ▷ Aircraft must have a **dual control system**.

More than 6 months since IFR current?

- An **Instrument Proficiency Check (IPC)** is **required**. Administered by a CFII, examiner, or other approved person. Guidelines are in the ACS.
- Some IPC tasks, but not all, can be conducted in a FTD or ATD. (See ACS)

To **meet recent instrument experience requirements**, the following **information** must be **recorded** in the person's **logbook**:

- **Location & type** of each instrument approach accomplished, and
- **The name of the safety pilot**, if required.

The IPC must cover these areas of operation:

- Air traffic control clearances and procedures.
- Flight by reference to instruments.
- Navigation systems.
- Instrument approach procedures.
- Emergency operations, and
- Post-flight procedures.

IFR recency of experience exemptions

- **A PIC who is actively employed by a Part 121 or 135 operator is exempt from the IFR recency of experience requirements of Part 61.57 when operating under Part 91, 121 or 135 (as applicable) for that operator as long as he complies with recency of experience requirements applicable for that operation.**
For example, a Part 121 airline pilot does not need to log "6 HITS" to operate under Part 91 or 121 for that airline as long as he is an active pilot with the company and current with that airline's FAA approved training schedule. **However, he is not IFR current for flying outside the airline unless he also complies with the 6 HITS within 6 months rule.**

USE OF FULL FLIGHT SIM, FTD, OR ATD FOR ACQUIRING INSTRUMENT AERONAUTICAL EXPERIENCE (§61.51)

- For training towards a certificate or rating, an authorized instructor is present to observe and signs the person's logbook to verify the time and content of the session.
 - For IFR recency requirements, log:
 - ▷ Training device, time and content.
- (§61.51, §61.56, §61.57, §91.109, Instrument- Airplane ACS)

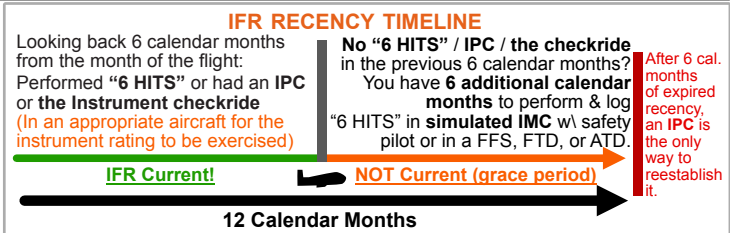
**LOGGING INSTRUMENT APPROACH PROCEDURES – REQUIREMENTS**

1. You must operate the aircraft, FFS, ATD or FTD **solely by reference to instruments.** – §61.51(g)(1)
 - ▷ A flight instructor may log an IAP conducted by the student in actual IMC. (See [FAA letter to Levy, 2008](#))
2. Be **established on each required segment of the IAP** down to its published minimums (MDA or DA).
 - ▷ The **Initial** (starting at the IAF), **Intermediate** and **Final approach segments are required for logging the approach, unless:**
 - ▷ **When radar vectored to final** by ATC. (In simulated IMC, vectors from the safety pilot are also accepted).
3. If conducted in **simulated IMC** in an **aircraft**, or in a **FFS, ATD or FTD, simulated conditions must continue down to MDA or DA.**
4. In an aircraft, **flight must be in actual or simulated IMC.**
5. In an aircraft, if conditions change from actual IMC to VMC during the final approach segment, you can still log the approach.

(See [FAA INFO 15012, 2015](#))

AERONAUTICAL DECISION MAKING**PREFLIGHT SELF-ASSESSMENT – “IM SAFE”**

- **I - Illness** - Do I have any symptoms?
- **M - Medication** - Have I taken prescription or over-the-counter drugs?
- **S - Stress** - Am I under psychological pressure, worried about finances, health or family discord?
- **A - Alcohol** - No drinking within 8 hours. ("8 hours bottle to throttle"). No more than .04% of alcohol in blood.
- **F - Fatigue** - Am I tired / adequately rested?
- **E - Emotion** - Am I emotionally upset?

(§91.17, AIM 8-1-1)

RISK MANAGEMENT & PERSONAL MINIMUMS – “PAVE”

- **P - Pilot** (general health, physical / mental / emotional state, proficiency, currency)
 - **A - Aircraft** (airworthiness, equipment, performance)
 - **V - Environment** (weather hazards, terrain, airports / runways to be used & other conditions)
 - **E - External pressure** (meetings, people waiting at destination, etc.)
- (Pilot's Handbook of Aeronautical Knowledge)

DECISION MAKING – “DECIDE”

- **D - Detect** that a change has occurred.
 - **E - Estimate** the need to counter the change.
 - **C - Choose** a desirable outcome.
 - **I - Identify** solutions.
 - **D - Do** the necessary actions.
 - **E - Evaluate** the effects of the actions
- (Pilot's Handbook of Aeronautical Knowledge)

PERSONAL DOCUMENTS REQUIRED FOR FLIGHT

- **Pilot Certificate**
- **Medical certificate** (or US Driver's license as permitted by §61.113 & §61.23)
- **Authorized photo ID (passport, driver's license, etc)**
- **Restricted Radiotelephone Operator Permit (For flights outside the US)**

AIRCRAFT DOCUMENTS REQUIRED FOR FLIGHT – “ARROW”

- A** - Airworthiness certificate
- R** - Registration certificate
- R** - Radio station license (for flights outside the US)
- O** - Operating limitations & information (in AFM)
- W** - Weight & Balance data (aircraft specific) (§21.5, §91.103, §91.9, §91.203, ICAO Article 29)

AIRCRAFT MAINTENANCE INSPECTIONS REQUIRED FOR IFR – “AVIATES”

- **A** - Airworthiness Directive (AD) required inspections. (§39)
- **V** - VOR check every 30 days. (For IFR; §91.171)
- **I** - Inspections: (§91.409)
 - ▷ **Annual inspection - 12 Cal. Months** (all aircraft).
 - ▷ **100-hour (time-in-service) inspection required if:**
 - **Carrying a person for hire** (other than crew member), or
 - **Flight instructing for hire** in an aircraft provided by the person giving the instruction.
 - **“For hire”** refers to the person, not the aircraft.
 - **Flight school providing airplane + instructor for hire:** 100-hours required
 - **Student-owned aircraft:** 100-hours not required.
 - **Rental (no pilot or instructor):** 100-hr not required.
 - The 100-hr inspection **may be exceeded by up to 10 hours** if aircraft is enroute to a place where it can be done. This additional time must be included in computing the next 100-hours inspection.
 - An annual inspection can substitute for the 100-hour if done within 100 hours of time-in-service.
 - ▷ A **progressive inspection** schedule, if specifically approved by the FAA, may replace the annual and 100 hour inspections.
- **A** - Altimeter, automatic altitude reporting (used by transponder) & static system every 24 calendar months. (For IFR in controlled airspace; §91.411)
- **I** - Transponder every 24 calendar months. (§91.413)
- **E** - ELT (§91.207)
 - ▷ **inspected every 12 calendar months.**
 - ▷ **Battery must be replaced after more than 1 hour of cumulative transmitter use or if 50% of its useful life has expired** (or, for rechargeable batteries, 50% of the useful life of charge has expired).
- **S** - Supplemental Type Certificate (STC) required inspections.

BRIEFINGS
PASSENGER BRIEFING – “SAFETY”

- **S**
 - ▷ **Seat belts fastened** for taxi, takeoff, landing.
 - ▷ **Shoulder harness fastened** for takeoff, landing.
 - ▷ **Seat position** adjusted and locked in place
- **A**
 - ▷ **Air vents location and operation**
 - ▷ **All environmental controls** (discussed)
 - ▷ **Action in case of any passenger discomfort**
- **F**
 - ▷ **Fire extinguisher** (location and operation)
- **E**
 - ▷ **Exit doors** (how to secure; how to open)
 - ▷ **Emergency evacuation plan**
 - ▷ **Emergency/survival kit** (location and contents)
- **T**
 - ▷ **Traffic** (scanning, spotting, notifying pilot)
 - ▷ **Talking, sterile flight deck expectations**
- **Y**
 - ▷ **Your questions? Speak up!**

(Pilot's Handbook of Aeronautical Knowledge)

TAXI BRIEFING – “ARCH”

- **A** - Assigned / planned runway.
- **R** - Route.
- **C** - Crossings and hold short instructions.
- **H** - Hot spots & Hazards (e.g., NOTAMs, closed taxiways/runways, surface condition).

TAKEOFF BRIEFING – “DEPARTS”

- D** - **Departure review** (e.g. takeoff type, initial heading, first fix & course, clearance readout).
- E** - **Establish Expectations** (e.g., flying pilot, PIC, positive transfer of controls).
- P** - **Plan / special considerations** (e.g., weather, visibility, terrain, unfamiliar field, inoperative equipment / MELs).
- A** - **Alternate** (takeoff alternate, if needed, or return plan)
- R** - **Runway conditions and length.**
- T** - **Trouble / Tactics** (e.g., rejected takeoff, engine failure).
- S** - **Speak up! Questions / concerns?**

PREFLIGHT INFO REQUIRED FOR IFR

“NW KRAFT” – §91.103

- **N** - NOTAMs.
- **W** - Weather reports and forecasts.
- **K** - Known traffic delays as advised by ATC.
- **R** - Runway length of intended use.
- **A** - Alternatives available if flight cannot be completed as planned.
- **F** - Fuel requirements
- **I** - Takeoff and landing performance data.

IFR FLIGHT PLAN §91.173

- **Requirement:** no person may operate an aircraft in controlled airspace under IFR unless that person has:
 - ▷ Filed an IFR flight plan; and
 - ▷ Received an appropriate ATC clearance.

⚠ **Although technically permitted by §91.173, taking off into IMC in uncontrolled airspace (Class G) without a clearance or a release, under certain conditions, was ruled by the NTSB as a violation of §91.13, careless or reckless operation and has gotten pilots in trouble with the FAA.** See [FAA letter to Lamb, 2016](#), and [NTSB Order EA-3935](#).

- **How to file an IFR flight plan?**
 - ▷ **FSS**
 - by phone (1-800-WX-BRIEF)
 - over the radio (GCO/RCO)
 - In person.
 - ▷ **Online**
 - [www.1800wxbrief.com](#) (Leido), [www.fltplan.com](#) (Garmin)
 - ▷ **EFB** (e.g., Foreflight)
 - ▷ With **ATC** (over radio, or phone if no other means available)
 - **Pop-up IFR clearances** let pilots transition from VFR to IFR, even **without a previously filed flight plan** (required by §91.173(a)), **under ATC authorization**.
 - While filing a flight plan (with FSS) is preferred, pop-ups allow to quickly get the flight into the system. (i.e. when weather is deteriorating fast during VFR). **They are subject to ATC workload** and not guaranteed.
 - You must be at or above the minimum IFR altitude, or climb to it under VFR.
- **File at least 30 minutes prior to estimated departure.** Non-scheduled flights **above FL230 should be filed at least 4 hours** before est. departure time. (AIM 5-1-6)
- **Flight plan cancellation** (AIM 5-1-15)
 - ▷ **Towered airports** - automatically canceled by ATC upon landing.
 - ▷ **Non-towered airports** - Pilot must contact ATC / FSS to cancel (by radio or phone)
 - ▷ **Can cancel anytime in flight if out of IMC and out of class A airspace.**
- **Preferred IFR Routes** are published in the Chart Supplement U.S. The AIM recommends filing a preferred route if one is available. (AIM 5-1-6)

IFR MINIMUM FUEL REQUIREMENTS §91.167

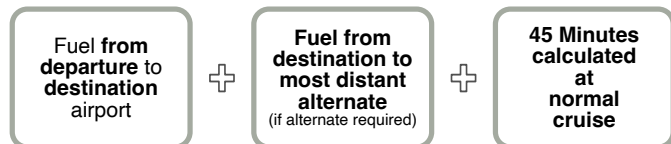

*Other fuel requirements exist for 121, 135, Flag and supplemental operations

IS A DESTINATION ALTERNATE REQUIRED? “1-2-3” RULE

A destination alternate is always required, unless:

- An instrument approach is published and available for the destination, AND,
- For at least 1 hour before to 1 hour after ETA:
 - ▷ **Ceiling** will be at least 2000' above airport elevation; and
 - ▷ **Visibility** will be at least 3 SM.

§91.169



MIN WEATHER CONDITIONS REQUIRED AT AN ALTERNATE

Use the alternate airport minima published in the procedure charts, or, if none:

- For a **Precision approach:** 600 ft ceiling and 2 SM visibility.
- For a **Non-precision approach:** 800 ft ceiling and 2 SM visibility.
- If **no instrument approach available at the alternate:** Ceiling & visibility must allow descent from MEA, approach and landing under VFR.

§91.169

FILING AN ALTERNATE - GPS CONSIDERATIONS

- **Equipped with a non-WAAS GPS?** Flight plan can be based on GPS approach availability at **either the destination or the alternate**, but **not at both**.
- **WAAS Without baro-VNAV?** Flight plan may be filed based on **LNAV or circling minima** at the **alternate** (regardless of the available approaches at the destination).
- **WAAS with baro-VNAV?** LNAV/VNAV or RNP 0.3 are allowed as basis for the flight plan's **alternate** (Requires Special Authorization & RNP availability). AIM 1-1-17b.5, 1-1-18c.9, 1-2-3d

IFR CRUISING ALTITUDES §91.179

Controlled airspace
IFR Cruising altitudes are as assigned by ATC.

Uncontrolled airspace

(Based on magnetic course)

Below FL290

- **0°-179°:** ODD thousands (below 18,000') or Flight Levels (at or above FL180)

- **180°-359°:** EVEN thousands (below 18,000') or Flight Levels (at or above FL180)

Above FL290 (in non-RVSM)

- **0°-179°:** Flight Levels at 4,000' intervals starting at FL290 (e.g., FL 290, 330, 370)
- **180°-359°:** Flight Levels at 4,000' intervals starting at FL310 (e.g., FL 310, 350, 390)

FL290-FL410 (in RVSM)

- **0°-179°:** Odd Flight Levels at 2,000' intervals starting at FL290 (e.g., FL 290, 310, 330)
- **180°-359°:** Even Flight Levels at 2,000' intervals starting at FL300 (e.g., FL 300, 320, 340)

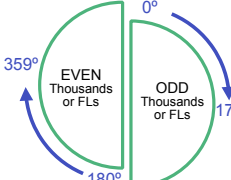

IFR TAKEOFF MINIMUMS

No T/O minimums mandated for Part 91 operations. For Part 121, 125, 129, 135:

- Prescribed T/O minimums for the runway, or, if none:
- 1-2 engines airplanes: 1 SM visibility (5000 RVR)
- More than 2 engines: ½ SM visibility (2400 RVR)

T Non-Standard TO minimums / Departure Procedures.

A Non-Standard IFR alternate minimums exist.

NA Alternate minimums not authorized due to unmonitored facility or the absence of weather reporting service.

§91.175

DEPARTURE PROCEDURES (DP)

AIM 5-2-9

- DPs ensure obstacle clearance, provided the aircraft:
 - ▷ crossed the departure end of the runway at least 35 ft AGL,
 - ▷ reaches 400 ft AGL before turning, and
 - ▷ climbs at least 200 Feet per NM (FPNM), or as published on the chart.
 - To convert FPNM to Feet-Per-Minute:
- $$FPM = FPNM \times \text{Groundspeed} / 60$$
- Pilots are encouraged to file and fly a DP at night, during marginal VMC or in IMC.
 - Two types of DP
 - ▷ Obstacle Departure Procedure (ODP)
 - Provides **obstacle clearance only**.
 - Printed either **textually or graphically**.
 - **Graphic ODPs** are titled “(OBSTACLE).”
 - ▷ Standard Instrument Departure (SID)
 - Provide **obstacle clearance and reduces pilot/controller workload** by simplifying ATC clearances and minimizing radio communications.
 - May include special **radio failure procedures**.
 - **SIDs are always published graphically**.
 - DPs are also categorized by required equipment:
 - ▷ **Non-RNAV DP**
 - Uses ground-based navigation (e.g., VOR, DME, NDB).
 - ▷ **RNAV DP**
 - Require at least RNAV 1 performance.
 - Identified with the word “RNAV” in the title.
 - ▷ **RADAR DP**
 - Uses ATC radar vectors to a route, NAVAID, or fix after departure.
 - Annotated “RADAR REQUIRED.”
 - **You are not required to accept a SID.** To avoid it, state “**NO SIDs**” in the flight plan’s remarks section.
 - **Transition routes** connect the end of the basic SID procedure to the enroute structure.
 - DPs are published in the “Take-Off Minimums and (Obstacle) Departure Procedures” section of the [Terminal Procedure Publication \(TPP\)](#)

DIVERSE DEPARTURE PROCEDURES

- When an Instrument Approach Procedure (IAP) is developed for an airport, each runway is assessed for departure obstacle clearance.
- This assessment ensures an aircraft can climb and turn in any direction from a runway while maintaining proper obstacle clearance.
 - ▷ All departures are initially assessed using a 40:1 (~152 FPNM) Obstacle Clearance Surface (OCS).
 - ▷ The standard required climb gradient is 200 FPNM, which provides 48 FPNM clearance over the 40:1 OCS.
 - ▷ The **Required Obstacle Clearance (ROC)** expands along the departure route until reaching 1,000 ft (non-mountainous areas) or 2,000 ft (mountainous)
 - ▷ The assessment area is limited to 25 NM (non-mountainous areas) or 46 NM (mountainous) from the departure airport.
 - ▷ Pilots are responsible for obstacle clearance beyond this distance when not operating on a published route, or when flying below the MEA, MOCA, or ATC assigned altitude.
- If a runway fails to meet the diverse departure criteria, an Obstacle Departure Procedure (ODP) is developed.

When departing with no ODP published (diverse departure criteria is met), pilots must:

- **Cross the Departure End of the Runway (DER) at least 35 feet above DER elevation**
- **Climb to 400 feet above DER elevation before making any turns**
- **Continue climbing until reaching the minimum IFR altitude.**

DIVERSE VECTOR AREA

- At some locations with an ODP, Diverse Vector Areas (DVA) are available to allow radar vectors in lieu of the pilot flying the ODP.
- A **DVA allows ATC to vector aircraft below the Minimum Vectoring Altitude (MVA) or Minimum IFR Altitude (MIA) immediately after takeoff** while still meeting obstacle clearance requirements.
- DVA information is found in the “Take-Off Minimums and (Obstacle) Departure Procedures” section of the TPP. It includes a statement that initial headings are provided by ATC and any applicable climb gradients.

CLIMB OVER AIRPORT (VCOA)

- **A departure option for IFR aircraft in VMC.**
- The pilot **visually conducts climbing turns over the airport up to the published “climb to” altitude**, from which he proceeds to the instrument portion of the departure.
 - Designed to avoid obstacles beyond 3 SM from the departure end of the runway (DER), as an alternative to complying with climb gradients greater than the standard 200 FPNM.
 - Advise ATC as early as possible prior to departure of the intent to fly a VCOA.
 - Published in the “Take-Off Minimums and (Obstacle) Departure Procedures” section of the TPP.
 - May appear as an option on graphic ODPs

IFR DEPARTURE CLEARANCE – “CRAFT”

- **C** - Clearance limit.
- **R** - Route.
- **A** - Altitude.
- **F** - Frequency (for departure).
- **T** - Transponder code.

Clearance void time – The time at which your clearance is void and after which you may not takeoff. You must notify ATC within 30 min after the void time if you did not depart.

“Hold for release” – You may not takeoff until being released for IFR departure.

Release time – The earliest time the aircraft may depart under IFR.

Expect Departure Clearance Time (EDCT) – A runway release time given under traffic management programs in busy airports. Aircraft are expected to depart no earlier and no later than 5 minutes from the EDCT.

Abbreviated departure clearance – “Cleared (...) as filed (...)”

(AIM 5-2-6)

STANDARD TERMINAL ARRIVAL (STAR)

- A STAR is an ATC-coded arrival procedure that serves as a **transition between the enroute structure and a point from which an approach to landing can be made.**
- **Transition routes** connect **enroute fixes** to the **basic STAR procedure.**
- STARS are usually **named after the fix at which the basic procedure begins.**
- As with a SID, pilots can state **“NO STARS”** in the remarks section of the flight plan **to avoid getting a clearance containing a STAR.**
- You do not have to accept a STAR, but once accepted, you must comply with it.
- STARS may be based on conventional navaids or RNAV capability.
- **RNAV STARS**
 - ▷ Normally designed with RNAV 1, RNP 1 or A-RNP NavSpecs
 - ▷ identified by **“RNAV”** in the title
- **STARS help to**
 - ▷ **Reduce pilot/controller workload**
 - ▷ **Minimize radio communications**
 - ▷ **Simplify clearance delivery**
- **Flying a STAR**
 - ▷ **Comply with lateral routing and published speed restrictions on the procedure, unless otherwise instructed by ATC.**
 - ▷ **Do not descent until authorized by ATC.**

CLIMB/DESCENT CLEARANCES

- **“Climb via** (the SIDs name)” - an abbreviated clearance that requires compliance with the procedure lateral path, associated speed and altitude restrictions along the cleared route or procedure. Clearance to “climb via” authorizes the pilot to: (AIM 5-2-9)
 - ▷ When used in the IFR departure clearance, in a PDC, DCL or when cleared to a waypoint depicted on a SID, to join the procedure after departure or to resume the procedure.
 - ▷ When vertical navigation is interrupted and an altitude is assigned to maintain which is not contained on the published procedure, to climb from that previously-assigned altitude at pilot’s discretion to the altitude depicted for the next waypoint.
 - ▷ Once established on the depicted departure, to navigate laterally and climb to meet all published or assigned altitude and speed restrictions.
- When an IFR clearance includes a STAR, pilots must maintain the last assigned altitude until receiving authorization to descend so as to comply with all published or issued altitude restrictions.
- **“Descend via** (the STAR’s name)”, authorizes pilots to: (AIM 5-4-1)
 - ▷ Descend at **pilot’s discretion to meet published restrictions** and laterally navigate on a STAR.
 - ▷ When cleared to a waypoint depicted on a STAR, to **descend from a previously assigned altitude at pilot’s discretion** to the altitude depicted at that waypoint.
 - ▷ Once established on the depicted arrival, to descend and to **meet all published or assigned altitude and/or speed restrictions.**
- **A climb/descend via clearance deletes previously assigned speed restrictions.** Pilots must still comply with speed restrictions published in the procedure. (AIM 4-4-12)
- **“Expect”** altitudes or Flight Levels
 - ▷ Not a clearance; used for planning purposes only
 - ▷ Pilots must not descend to an “expect” altitude without additional ATC clearance
- **“Maintain** (altitude)”
 - ▷ Normally preceded by the phrase “climb and” or “descend and”.
 - ▷ Pilot should begin the climb or descent to the assigned altitude upon receipt of the clearance.
 - ▷ In the US, any published restrictions on a STAR above the assigned altitude are cancelled.
- **“Cross** (fix) **at** (altitude)” or **“at or above/below** (altitude)”
 - ▷ Start climb/descent at pilot discretion and comply the crossing restriction.

CRUISE CLEARANCE

A “cruise clearance” can be issued by ATC to allocate a block of airspace to the flight. **This airspace begins at the minimum IFR altitude and extends to the altitude (including) specified in the clearance.**

Within this block, you are free to climb and descend. However, once you start descending and verbally report leaving an altitude, you may not return to it without additional ATC clearance.

A cruise clearance also allows you to begin an approach at the destination without receiving an additional “cleared for approach” clearance.

However, this clearance does not allow the pilot to descend under IMC below the applicable minimum IFR altitudes nor does it imply ATC is exercising control over aircraft in class G airspace.

Example: “N12345 Cruise 6 Thousand” (Pilot/Controller Glossary)

IFR ALTITUDES

Minimum IFR Altitudes (§91.177)

■ **Except for takeoff or landing**, or otherwise authorized by the FAA, **no person may operate an aircraft under IFR below -**

- ▷ **Minimum altitudes prescribed for the flown segment, or if none:**
- ▷ **Mountainous areas: 2,000 ft** above the **highest obstacle within a horizontal distance of 4 NM** from the course.
- ▷ **Non-mountainous areas: 1,000 ft** above the highest obstacle within **4 NM** from the course.

IFR altitudes definitions (§91.177, Pilot/Controller Glossary)

- **DA / H - Decision Altitude / Height:** the Altitude (MSL) / Height (above runway threshold), on a vertically guided instrument approach procedure (ILS, LNAV/VNAV, LPV, etc) at which the pilot must decide whether to continue the approach or to go around.
- **MAA - Maximum Authorized Altitude.** Annotated “MAA-17000” (17,000ft as an example) on IFR charts.
- **MCA - Minimum Crossing Altitude.** The lowest altitude at certain fixes that an airplane must cross when flying in the direction of a higher MEA.
- **MDA / H - Minimum Descent Altitude / Height:** The lowest Altitude (MSL) / Height (above runway threshold) to which descent is authorized on a non-precision approach until the pilot sees the visual references required for landing.
- **MEA - Minimum Enroute Altitude:** The lowest published altitude between radio fixes which assures acceptable navigational signal coverage and meets obstacle clearance requirements. An MEA gap establishes an area of loss in navigational coverage and annotated “MEA GAP” on IFR charts.
- **MOCA - Minimum Obstruction Clearance Altitude:** The lowest published altitude in effect between radio fixes on VOR airways, off-airway routes, or route segments which meets obstacle clearance requirements for the entire route segment and which assures acceptable navigational signal coverage only within 22 NM of a VOR.
 - ▷ **If both an MEA and a MOCA are prescribed** for a particular route segment, **a person may operate an aircraft lower than the MEA down to, but not below the MOCA, provided the applicable navigation signals are available.** For aircraft using VOR for navigation, this applies only when the aircraft is within **22 NM of the VOR.** (§91.177)
- **MORA - Minimum Off Route Altitude** (Jeppesen):
 - ▷ **Route MORA** provides obstruction clearance within 10NM to either side of airway centerlines and within a 10NM radius at the ends of airways.
 - ▷ **Grid MORA** provide obstruction clearance within a latitude / longitude grid block.
- **MRA - Minimum Reception Altitude.** The lowest altitude on an airway segment where intersection can be determined using radio navigational aids.
- **MTA - Minimum Turning Altitude:** Provides vertical and lateral obstacle clearance in turns over certain fixes. Annotated with the MCA X icon and a note describing the restriction.
- **MVA - Minimum Vectoring Altitude:** The lowest altitude at which an IFR aircraft will be vectored by a radar controller, except as otherwise authorized for radar approaches, departures, and missed approaches. MVAs may be lower than the minimum altitudes depicted on aeronautical charts, such as MEAs or MOCAs.
- **OROCA - Off Route Obstruction Clearance Altitude:** Provides obstruction clearance with a 1,000 ft buffer in non-mountainous terrain areas and 2,000 ft in mountainous areas. OROCA may not provide navigation or communication signal coverage.

*Designated mountainous areas are defined in 14 CFR part 95 by lat / long coordinates.

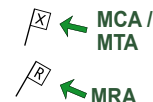
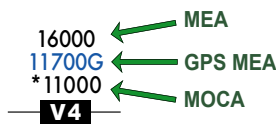

FLIGHT INSTRUMENTS

GYROSCOPIC INSTRUMENTS

- **Two principles** of a **gyroscope**:

- ▷ **Rigidity in space**, and
- ▷ **precession**.

Attitude Indicator (AI)

Operates on the principle of **rigidity in space**. Shows **bank and pitch information**. Older AIs may have a tumble limit. Should show correct attitude within 5 minutes of starting the engine. Normally vacuum-driven in GA aircraft, may be electrical in others. May have small acceleration/deceleration errors (accelerate-slight pitch up, decelerate- pitch down) and roll-out errors (following a 180 turn shows a slight turn to the opposite direction).

Heading indicator (HI)

Operates on the principle of **rigidity in space**. It only reflects changes in heading, but cannot measure the heading directly. You have to calibrate it with a magnetic compass in order for it to indicate correctly. HIs may be slaved to a magnetic heading source, such as a flux gate, and sync automatically to the present heading. Normally powered by the vacuum system of GA aircraft.

Turn Indicators

Operates on the principle of **precession**.

- ▷ **Turn coordinators** show **rate-of-turn** and **rate of roll**.
- ▷ **Turn-and-slip indicators** show **rate-of-turn only**.

PITOT-STATIC INSTRUMENTS

Altimeter

- An **aneroid barometer** that shows the height above a given pressure level, based on standard pressure lapse rate of 1000' per inch of mercury.
- A stack of sealed aneroid wafers expand and contract with changes in atmospheric pressure received from the static port.
- A **mechanical linkage** between the aneroid and the display translates the sensed pressure to an altitude indication.
- An **altimeter setting knob** (on a "sensitive altimeter", which are most aircraft altimeters) allows the pilot to adjust the current pressure to the current altimeter setting published locally (available from ATIS, METAR or ATC).
- The pressure setting is displayed in the "**Kollsman Window**" in mb and/or inches of mercury (Hg)
- In the US, when operating below 18,000' MSL **regularly set the altimeter to a station within 100 NM. Above 18,000' MSL**, the altimeter should be **set to the standard sea level pressure of 29.92" Hg**, and operate in **Flight Levels (FL)**.
- "**High to Low - Watch out below!**". Use caution when flying from high pressure to low pressure areas. If altimeter setting is not updated, altitude will indicate higher, causing the pilot to fly lower than desired. Flying from **hot to cold** areas results in the same error.

Types of altitude

- **Indicated altitude** – Uncorrected altitude indicated on the dial when set to local pressure setting (QNH).
- **Pressure altitude** – Altitude above the standard 29.92. Hg plane (QNE). Used when flying above the transition altitude (18,000' in the US)
- **Density altitude** – Pressure alt. corrected for nonstandard temperature. Used for performance calculations.
- **True altitude** – Actual altitude above Mean Sea Level (MSL).
- **Absolute altitude** – Height above airport elevation (QFE).

Vertical Speed Indicator (VSI)

- Indicates **rate-of-climb** in fpm (accurate after a 6-9 sec. lag), and **rate trend** (immediately with rate change).
- A diaphragm inside the instrument is connected directly to the static source.
- The area outside the diaphragm also receives static pressure, but via a calibrated leak (a restricted orifice).
- This configuration essentially responds to static pressure change over time.
- As the diaphragm expands or contracts, a mechanical linkage moves the pointer needle to display the current rate of climb to the pilot.
- **Instantaneous VSI** (IVSI) solves the lag issue with the addition of vertical accelerometers.

Pitot-Static Instruments – Continued

Airspeed Indicator (ASI)

- The airspeed indicator measures the difference between impact (ram) air pressure from the pitot tube and ambient pressure from the static port. The result pressure is called dynamic pressure and corresponds to airspeed.
 - ▷ Dynamic Pressure (airspeed) = Impact Pressure – Static pressure.
- A diaphragm in the instrument receives ram pressure from the pitot tube. The area outside the diaphragm is sealed and connected to the static port. A mechanical linkage converts the expansion and contraction of the diaphragm to airspeed shown on the display dial.

Types of speed

- **Indicated airspeed (IAS)** – indicated on the airspeed indicator
- **Calibrated airspeed (CAS)** – IAS corrected for instrument & position errors.
- **Equivalent airspeed (EAS)** – CAS corrected for compressibility error.
- **True airspeed (TAS)** – Actual speed through the air. TAS is CAS corrected for nonstandard temperature and pressure. At supersonic and transonic speeds, TAS is more accurately derived from EAS, rather than CAS.
- **Mach number** – The ratio of TAS to the local speed of sound.
- **Ground speed** – Actual speed over the ground. TAS corrected for wind conditions.

AIRSPEED INDICATOR MARKINGS

- **White arc** - Flap operating range. Starts at Vs0; ends at Vfe
- **Green arc** - Normal operating range. Starts at Vs1; ends at Vno
- **Yellow arc** - Caution range. Fly only in smooth air and only with caution.
- **Red line** - Vne

V-SPEEDS

- **Va** - Design maneuvering speed
- **Vs** - Stall speed, clean config.
- **Vs0** - Stall speed landing config.
- **Vs1** - Stall speed specific config.
- **Vfe** - Max flap extended speed.
- **Vno** - Max structural cruise speed
- **Vne** - Never Exceed Speed
- **Vx** - Best angle of climb
- **Vy** - Best rate of climb

STATIC PORT BLOCKAGE

- **Airspeed indicator** – **Indicates correctly only at the blockage altitude.**
 - ▷ Higher altitudes → airspeed indicates lower than it should.
 - ▷ Lower altitudes → Indicates higher than it should.
- **Altimeter** – will **freeze on the altitude where it was blocked.**
- **VSI** – **freezes on zero.**
 - ▷ After verifying a blockage in the static port, you should use an alternate static source or break the VSI window (in which case, **expect reverse VSI** information).
- When using the **alternate static source**: (a lower static pressure is measured)
 - ▷ **Airspeed indicator** – indicate a faster speed than it should.
 - ▷ **Altimeter** – indicate higher than it should.
 - ▷ **VSI** – momentarily show a climb.

PITOT TUBE BLOCKAGE

The **only instrument affected** is the **airspeed indicator**.

- Ram air inlet clogged and drain hole open? Airspeed drops to zero.
- Both air inlet and drain hole are clogged? The airspeed indicator will act as an altimeter, and will no longer be reliable.
- When suspecting a pitot blockage, consider the use of pitot heat to melt ice that may have formed in or on the pitot tube.

GENERIC INSTRUMENT TAXI CHECK

- **Airspeed** – 0 KIAS.
- **Turn coordinator** – ball centered and wings level when not turning. On turns: shows turn in correct direction, ball goes to opposite direction of the turn.
- **Attitude** – Correct pitch attitude and bank angle ±5 within 5 minutes of engine start (if vacuum).
- **Heading indicator** – Set and shows correct headings.
- **Altimeter** – Set to local altimeter settings or to airport elevation (\$91.121). Shows surveyed elevation ±75 ft (AIM 7-2-3).
- **VSI** – 0 fpm.
- **Magnetic compass** – swings freely, full of fluid, shows known headings and deviation card is installed. Marker beacons – Tested.
- **NAV & Comm** – Set.
- **GPS** – Checked and set.
- **EFIS cockpits** – Check PFD/MFD/EICAS for 'X's, messages, warnings and symbols.

<p>MAGNETIC COMPASS ERRORS & LIMITATIONS – “DV MONA”</p> <ul style="list-style-type: none"> ■ D- Deviation ■ M- Magnetic dip ■ N- North/south turn errors - Northern hemisphere: UNOS Undershoot North/ Overshoot South ■ V- Variation ■ O- Oscillation ■ A- Acceleration errors - Northern hemisphere: ANDS Accelerate North/ Decelerate South 	
<p>ELECTRONIC FLIGHT INSTRUMENTS</p> <ul style="list-style-type: none"> ■ Attitude Heading Reference Systems (AHRS) – Provides more accurate and reliable attitude and heading data than traditional separate gyro systems. The first AHRS units were very expensive and relied on laser gyros and flux valves. Today they are based on solid state technologies (no moving parts) and are cheaper, smaller and easier to maintain. ■ Air Data Computers (ADC) – replaces the mechanical pitot-static instruments. The ADC receives inputs from the pitot, static and outside temperature ports and computes airspeed, true airspeed, vertical speed and altitude. ■ Flight director – computes and displays command bars over the attitude indicator to assist the pilot in flying selected heading, course or vertical speed. ■ Flight Management System (FMS) – Receives inputs from various sensors and provides guidance to the autopilot and flight director throughout the flight. The FMS also automatically monitors and selects the most appropriate navigation source for accurate positioning. (GPS, VOR/DME, INS etc.) ■ Electronic Flight Instrument Systems (EFIS) – AKA “Glass cockpit”. ■ Primary Flight Displays (PFD) – Displays flight data such as attitude, altitude, airspeed, VSI and heading as well as rate tapes. ■ Multi-Function Displays (MFD) – Displays a variety of information such as moving maps, aircraft system status, weather and traffic. It may also be used as a backup for other displays, such as the PFD or EICAS. 	
<p>For VFR day: “A TOMATO FLAMES” –</p> <p>A - Altimeter</p> <p>T - Tachometer for each engine.</p> <p>O - Oil temperature indicator for each engine.</p> <p>M - Manifold pressure gauge for each altitude engine.</p> <p>A - Airspeed indicator.</p> <p>T - Temperature gauge for each liquid cooled engine.</p> <p>O - Oil pressure gauge for each engine.</p> <p>F - Fuel quantity gauge for each tank.</p> <p>L - Landing gear position lights (if retractable gear).</p> <p>A - Anticollision lights (for aircraft certified after March 11, 1996).</p> <p>M - Magnetic direction indicator (magnetic compass).</p> <p>E - ELT, if required by §91.207.</p> <p>S - Safety belt / shoulder harness.</p>	<p>MINIMUM EQUIPMENT REQUIRED FOR FLIGHT §91.205</p> <p>For IFR day: all VFR day equipment + GRABCARD For IFR night: all VFR day + VFR night + GRABCARD</p> <p>“GRAB CARD” –</p> <p>G - Generator / alternator.</p> <p>R - Radios. Two-way radio communication & navigational equipment suitable for the route to be flown.</p> <p>A - Altimeter (sensitive, adjustable for barometric pressure)</p> <p>B - Ball (slip-skid indicator).</p> <p>C - Clock. Shows hours, minutes and seconds with sweep-second pointer or digital representation. Installed as part of aircraft equipment.</p> <p>A - Attitude indicator.</p> <p>R - Rate-of-turn indicator.</p> <p>D - Directional gyro (heading indicator).</p>
<p>For VFR night: All VFR day equipment + FLAPS “FLAPS” –</p> <p>F - Fuses (spare set).</p> <p>L - Landing light (if for hire) .</p> <p>A - Anticollision lights.</p> <p>P - Position lights (navigation lights).</p> <p>S - Source of electrical power (i.e., battery).</p>	<p>OPERATING WITH INOPERATIVE ITEMS (§91.213)</p> <pre> graph TD A{Aircraft has an MEL?} -- Yes --> B[Follow MEL provisions] A -- No --> C[Is the inoperative equipment required by: - VFR-day type certification requirements? - Equipment list or kind of operations equipment list? - §91.205 or other regulations for kind of operations? - An Airworthiness Directive (AD)?] C -- No --> D[Flying is permitted, provided: - Inoperative equipment is removed (affecting weight & balance), or - deactivated and placarded "Inoperative." - Pilot/mechanic determines no hazard from inop. item.] C -- Yes --> E[Flying not allowed without a special flight permit] </pre>
<p>If operating for hire over water and beyond power-off gliding distance from shore: (unless Part 121)</p> <ul style="list-style-type: none"> ■ An approved flotation device for each occupant ■ At least one pyrotechnic signaling device <p>Flight at and above FL240: When using VOR for navigation, DME or RNAV is also required.</p>	

RADIO NAVIGATION

VHF OMNI DIRECTIONAL RANGE (VOR)

- 108.0 to 117.95 MHz, excluding 108.10-111.95 with odd tenths (reserved for LOC frequencies).
- Full scale deflection: 10°.
- Standard service volumes do not apply to published routes.
- Pilot must verify correct and usable VOR station with morse ID before using it.
- The VOR MON (VOR Minimum Operational Network) program ensures that as old VORs are decommissioned, a MON airport (i.e., equipped with legacy ILS or VOR approach) is available within 100 NM regardless of aircraft position in the CONUS.

VOR Receiver Checks (§91.171)

- Perform every 30 calendar days
 - ▷ VOT ±4°
 - ▷ Repair Station ±4°
 - ▷ VOR ground checkpoint ±4°
 - ▷ VOR airborne checkpoint ±6°
 - ▷ Dual VOR cross-check ±4°
 - ▷ Above a prominent ground landmark on a selected radial at least 20 NM from a VOR, flying at a "reasonable low altitude" ±6°

VOR check sign-off (§91.171)

- D.E.P.S –
- D - Date
 - E - Error (bearing error)
 - P - Place
 - S - Signature

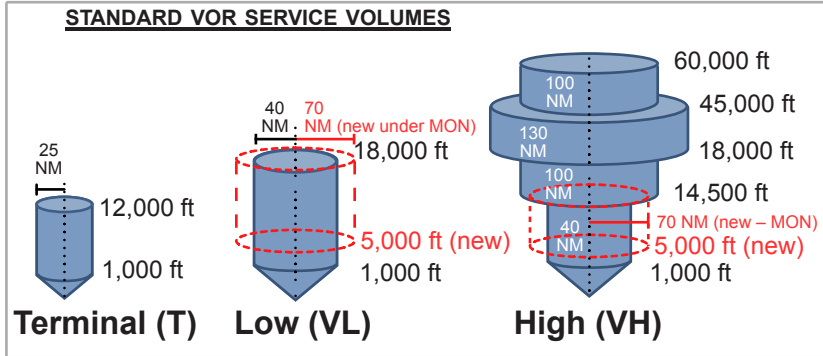

VOR limitations

- Cone of confusion
- Reverse sensing (if used incorrectly)
- Requires line-of-sight between aircraft and station.

DISTANCE MEASURING EQUIPMENT (DME)

- 962-1213 MHz (UHF).
- Normally tuned automatically with a paired VHF station (VOR/LOC).
- The Airborne DME unit transmits an interrogation signal.
- The ground DME facility receives and replies to the interrogation.
- Airborne unit calculates the slant range distance to the station based on the reply time.
- Due to slant range error, when flying overhead the station, DME indicates greater than zero.
- Slant range error is negligible at 1 NM DME station per every 1000ft height. For example, at 5000 ft, slant range error is negligible when further than 5 NM of the station.

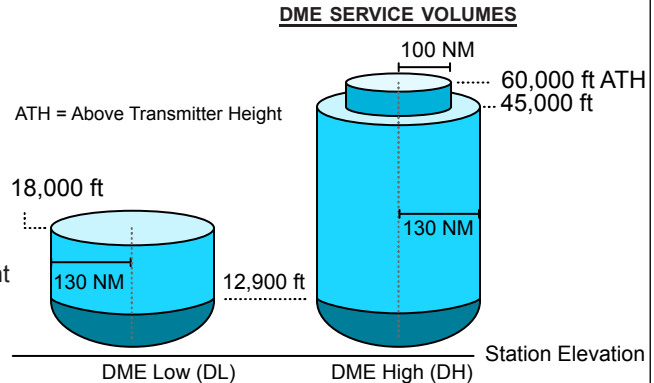

NON-DIRECTIONAL BEACON (NDB)

- 190-535 kHz (also receive and point towards commercial radio AM station at 550 -1650 kHz).
- Low to medium frequency band.
- ADF (Automatic Direction Finder) in aircraft points towards the NDB.
- Magnetic Bearing = Magnetic Heading + Relative Bearing

COMPASS LOCATOR

A low-powered NDB (at least 25 Watts and 15NM range) installed at the OM or the MM on some ILS approaches.

NDB Service Volume Classes	
Compass Locator	15 NM
Medium High (MH)	25 NM
High (H)	50 NM (or less, see NOTAM or Chart Supplement)
High High (HH)	75 NM

INSTRUMENT LANDING SYSTEM (ILS)

Localizer AIM 1-1-9

- Provides **lateral course guidance**.
- **Frequencies:** 108.1 - 111.95 MHz with odd tenths only. 90 and 150 Hz signals are carried over the VHF frequency and used by the receiver interpret the aircraft's lateral position.
- **Width:** Between 3°-6° so that the width at the threshold would be 700 feet. Usually 5° total width. (2.5 full deflection to each side, 4 times more sensitive than a VOR).
- **Coverage range:** 35° to each side of the centerline for the first 10NM and 10° up to 18NM from the antenna and up to an altitude of 4500'.

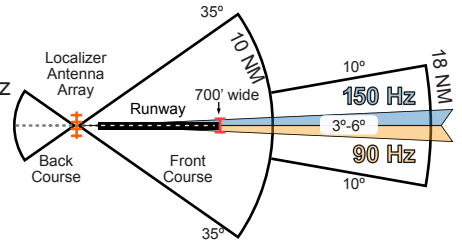

Glide Slope AIM 1-1-9

- Provides **vertical course guidance**.
- **Frequencies:** 329.3 to 335 MHz (UHF), automatically tuned with the localizer. Vertical position is interpreted by the intensity of 90 and 150 Hz signals carried over the UHF frequency and directed above and under the slope.
- **Width:** 1.4° (full deflection is 0.7° either direction).
- **Range:** typically up to 10 NM.
- **Slope:** typically 3°.
- **Errors:** **False glide slope** above normal glide slope.

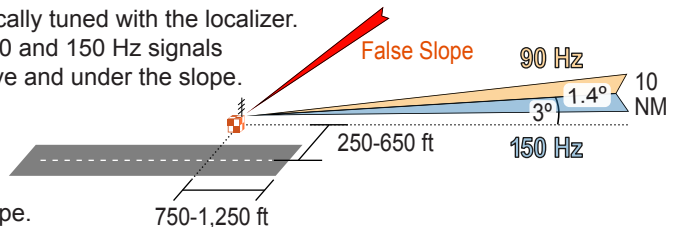

Marker Beacons

- Provide **range information** over specific points along the approach. Transmits at 75 MHz.
- **Outer marker:** 4-7 miles out. Indicate the position at which the aircraft should intercept the GS at the appropriate interception altitude ±50ft. **BLUE**. “- - -”
- **Middle marker:** ~3500ft from the runway. Indicates the approximate point where the GS meets the decision height. Usually 200ft above the touchdown zone elevation. **AMBER**. “. - -”
- **Inner marker:** between the MM and runway threshold. Indicates the point where the glide slope meets the DH on a CAT II ILS approach. **WHITE**. “. . .”
- **Back course marker:** Indicates the FAF on selected back course approaches. **Not part of the ILS approach.** **WHITE** “. . .”

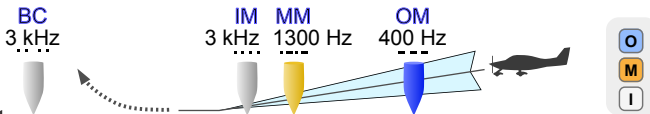

Approach Light System (ALS) AIM 2-1-1

- Provides basic **visible means to transition between instrument-guided flight into a visual approach**.
- ALS **extends from the landing threshold into the approach area** up to:
 - ▷ **2,400-3,000** feet for **precision instrument runways**, and
 - ▷ **1,400-1,500** feet for **non-precision instrument runways**.
- May include **Sequenced Flashing Lights**, which appear to the pilot as a ball of light traveling towards the runway at twice a second (AKA “The Rabbit”).
- The visible parts of the ALS configuration can help the pilot estimate flight visibility.



ILS Category	Lowest Visibility	Lowest DH
CAT I	2,400' or 1,800'	200'
CAT II	1,200'	100'
CAT IIIa	>700'	<100' or no DH
CAT IIIb	150'-700'	<50' or no DH
CAT IIIc	0'	No DH

AIM 1-1-9

AREA NAVIGATION (RNAV)

- Allows navigation on any desired path without the need to overfly ground-based facilities.
- **Types:**
 - ▷ Global Navigation Satellite System (**GNSS**) (e.g., **GPS**, Galileo, GLONASS, BeiDou)
 - ▷ VOR/DME RNAV
 - ▷ DME/DME RNAV
 - ▷ Inertial Reference Unit / System (IRU/ IRS)
- **RNAV VNAV - Vertical NAVigation** guidance.
- **BARO-VNAV** - An RNAV system that uses the barometric altitude to compute vertical guidance for the pilot.
- Published RNAV routes include Q (FL180 to FL450) and T (1,200 AGL to 18,000 MSL) routes and are designated RNAV 2 unless charted as RNAV 1.
- Magnetic Reference Bearing (MRB) - the published bearing between two waypoints on an RNAV route.

GLOBAL POSITIONING SYSTEM (GPS)

- **GPS** is a **Global Navigation Satellite System (GNSS)** operated **by the United States**.
- The constellation consists of a minimum of 24 satellites (with some spares) orbiting above the earth at 10,900 NM. The system is designed so that at least 5 satellites are in view at any given location on earth.
- The Aircraft's GPS receiver calculates the distance to a GPS satellite based on the time lapse since the broadcast timestamp (obtained from an atomic clock onboard the satellite) and the time it received the signal.
- Using only one satellite, the aircraft could virtually be on any point on a sphere surrounding the satellite, with the calculated distance ("pseudo-range") as the sphere's radius.
- The GPS receiver uses the intersection of spheres, from multiple satellites, to calculate the aircraft's geographical position. Course and speed data are computed from aircraft position changes.
- At least **3 satellites are required for 2D** position. (latitude and longitude); at least **4 satellites are required for 3D** position. (latitude, longitude and altitude).
- **Receiver Autonomous Integrity Monitoring (RAIM)** is a function of GPS receivers that monitors the integrity of the satellite signals.
 - ▷ RAIM (fault detection) requires a minimum of 5 satellites, or, 4 satellites + an altimeter input (baro-aided RAIM)
 - ▷ To eliminate a corrupt satellite (fault exclusion), RAIM needs an additional satellite (total of 6 or 5 + baro-aid)
- A database loaded into the receiver unit contains navigational data such as: airports, nav aids, routes, waypoints and instrument procedures.
- Airborne GPS units use **great-circle navigation**.
- **GPS CDI** deflection shows **distance**, unlike a VOR's CDI, which presents an **angular distance** off course in degrees.
- GPS can substitute ADF or DME, except for ADF substitution on NDB approaches without a GPS overlay ("or GPS" in title).
- **Check GPS NOTAMS before the flight** and use **RAIM prediction** if available on your receiver.
- **GPS Augmentation systems, or Differential GPS (DGPS)** – Improves the accuracy of GPS by measuring errors received by reference stations at known geographical locations and then broadcasting those errors to supported GPS receivers.
 - ▷ **Satellite Based Augmentation System (SBAS)**
 - **Wide Area Augmentation System (WAAS)** in the US; **EGNOS** in **Europe**.
 - Ground stations (Wide-area Reference Stations and Wide-area Master Stations) measure GPS errors and produce correction signals. These corrections are broadcasted back to the satellite segment from which they are bounced back to aircraft GPS WAAS receivers to improve **accuracy, integrity and availability monitoring** for GPS navigation.
 - **Covers a wide area.**
 - Facilitates **APV approaches** such as **LPV** and **LNAV/VNAV** and **non-precision LP approaches**.
 - ▷ **Ground Based Augmentation System (GBAS)**
 - Formerly named **Local Area Augmentation System (LAAS)** in the US. Now replaced with the ICAO term "GBAS."
 - Errors are broadcasted **via VHF** to GBAS-enabled GPS receivers.
 - GBAS is **more accurate than WAAS** but **covers a much smaller geographical area**.
 - Allows for **category I** and above approaches to **GLS DA** minima.

REQUIRED NAVIGATION PERFORMANCE (RNP)

- RNP is:
 - ▷ A statement of navigation equipment and service performance.
 - ▷ RNAV with navigation monitoring and alerting.
- **All RNAV approaches are RNP approaches**
 - ▷ Most US RNP approaches are titled “RNAV (GPS)”.
 - ▷ US Approaches with “RNAV (RNP)” in the title are “AR” (Authorization Required) approaches, which **require special FAA approval for the crew, aircraft and operation.**
 - ▷ In other countries, all RNP approaches may have “RNP” in the title, even those that do not require special authorization.

RNP approach minima and equipment:

- GLS DA minima using GBAS (formerly LAAS)
- LP MDA or LPV DA minima require RNP achieved by WAAS.
- LNAV / VNAV DA achieved by VNAV-approved WAAS, or BARO-VNAV systems.
- LNAV MDA - achieved by a basic, **unaugmented** IFR-approved GPS.

Clarifying The Difference Between RNAV, GNSS, GPS, PBN and RNP

- **Area Navigation (RNAV)**
 - ▷ RNAV is a system that enables navigation between any two points without the need to overfly ground-based stations.
- **GNSS** is a broad term for satellite-based RNAV systems.
 - ▷ GPS is the GNSS operated by the USA. Other examples are GLONASS by Russia and Galileo by the EU.
- **Performance Based Navigation (PBN)**
 - ▷ PBN is a general basis for navigation equipment standards, in terms of accuracy, integrity, continuity, availability and functionality for specific operation contexts (e.g., final approach, enroute, missed approach).
- **Required Navigation Performance (RNP)**
 - ▷ RNP is a specific **statement of PBN** for the flight segment and aircraft capability.
 - ▷ RNP is also defined as **RNAV + navigation monitoring and alerting functionality.**
 - Receiver Autonomous Integrity Monitoring (RAIM) or built-in monitoring in WAAS provide this capability.
 - ▷ **Enroute – RNP 2.0 (2 NM accuracy 95% of the flight time)**
 - ▷ **Terminal & Departure – RNP 1.0 (1 NM accuracy 95% of the flight time)**
 - ▷ **Final Approach – RNP 0.3 (0.3 NM accuracy 95% of flight time)**
 - ▷ **Advanced RNP (A-RNP) - a higher RNP standard mandatory for RNP AR, that require capability for:** (AIM 1-2-2)
 - Radius-to-Fix (RF) legs
 - Scalable RNP - can gradually vary between 1.0 and 0.3 (or as low as 0.1) RNP values, and
 - Parallel offset flight path generation

ATTITUDE INSTRUMENT FLYING

Basic attitude instrument flying skills:

- Cross Check
- Instrument interpretation
- Aircraft Control

Common Errors:

- Fixation
- Omission
- Emphasis

- **Control & Performance Method** – Divides the cockpit panel by **control instruments** and **performance instruments**.
First, set the power and attitude, then monitor the performance and make adjustments.
 - ▷ **Control instruments**
 - Power - Tachometer, Manifold pressure, EPR, N1, etc.
 - Attitude - Attitude Indicator
 - ▷ **Performance Instruments**
 - Pitch: altimeter, airspeed and VSI
 - Bank: Heading Indicator, Turn Coordinator, and magnetic compass
- **Primary & Supporting Method** – Divides the cockpit panel by **Pitch, Bank, and Power instruments**.
 - ▷ **Pitch instruments:** Attitude Indicator, Altimeter, Airspeed Ind., and VSI.
 - ▷ **Bank instruments:** Attitude ind., Heading ind., Mag. Compass, and Turn Coordinator.
 - ▷ **Power instruments:** Airspeed, Tachometer, Manifold pressure
 - ▷ For a specific maneuver, primary instruments provide the most essential information for pitch, bank and power while supporting Instruments back up and supplement the information presented by the primary instruments.
 - ▷ Example, for a constant rate climb with a standard rate turn –
 - Primary: Pitch - VSI; Bank - Turn Coordinator; Power - RPM / MP
 - Secondary: Pitch - ASI; attitude, Bank - AI, HI, Mag. Compass; Power - ASI

REQUIRED REPORTS UNDER IFR

“MARVELOUS VFR C500” -

(AIM 5-3-3, §91.183, §91.187)

- **M**issed approach
- **A**irspeed ± 10 kts / 5% change of filed **TAS** (whichever is greater)
- **R**eaching a holding fix (report time & altitude)
- **V**FR on top when an altitude change will be made.
- **E**TA changed ± 2 min, or ± 3 min in North Atlantic (NAT) *
- **L**eaving a holding fix/point
- **O**uter marker (or fix used in lieu of it) *
- **U**nforecasted weather (§91.183)
- **S**afety of flight (any other information related to safety of flight, §91.183)
- **V**acating an altitude / FL
- **F**inal Approach fix *
- **R**adio/Nav/approach equipment failure (§91.187)
- **C**ompulsory reporting points ▲ * (§91.183)
- **500** - unable climb/descent 500 fpm

* Required only in non-radar environments (including ATC radar failure)

HOLDING PATTERNS

(AIM 5-3-8)

- ATC may assign holding instructions to delay or separate traffic in the air for reasons such as weather or airport closures.

Non-charted holding clearance items:

- ▷ **D**irection of hold from the fix (e.g., N, W, S, NE)
- ▷ **H**olding Fix
- ▷ **R**adial, course, airway, or route on which to hold.
- ▷ **L**eg length in miles (if DME or RNAV) or minutes otherwise.
- ▷ **D**irection of turns (if left). Otherwise, right turns are standard.
- ▷ **E**xpect Further Clearance (EFC) time

Charted holding clearance items

- ▷ **H**olding Fix
- ▷ **D**irection of hold from fix (e.g., N, W, S, E)
- ▷ **E**FC
- **S**tart speed reduction **3 minutes before reaching the hold fix.**
- **A**ctions at hold fix and each turn point **5 Ts**
 - ▷ **T**urn
 - ▷ **T**ime
 - ▷ **T**wist
 - ▷ **T**hrottle
 - ▷ **T**alk

MAKE ALL HOLD TURNS:

- 3° per second, or
- 30° bank angle, or
- 25° bank angle if using a Flight Director

*Whichever uses the least bank angle

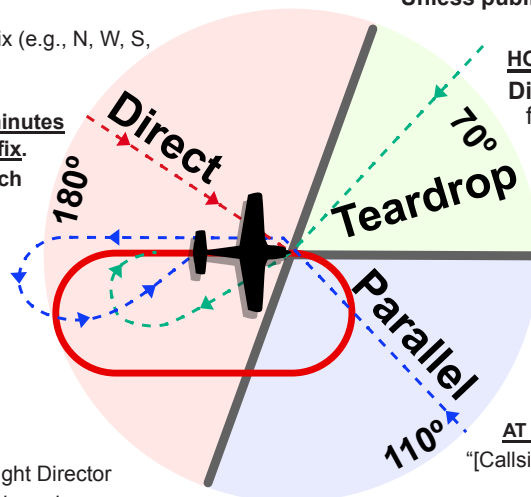

POSITION REPORT ITEMS

REQUIRED IN NON-RADAR ENVIRONMENT

“A PTA TEN R” -

(§91.183, AIM 5-3-2)

- **A**ircraft ID.
- **P**osition.
- **T**ime.
- **A**ltitude.
- **T**ype of flight plan (except when communicating with ARTCC / Approach control).
- **E**TA and name of next reporting fix.
- **N**ame only of the next succeeding point along the route of flight.
- Any pertinent **remarks**.

HOLDING PATTERN TIMING

- Start timing outbound abeam/over the fix (whichever is later). Or, if the abeam point cannot be determined, start the time at the completion of the outbound turn.
- Adjust the outbound leg so the inbound leg takes:
 - ▷ **At or below 14,000' MSL – 1 minute**
 - ▷ **Above 14,000' MSL – 1.5 minutes**
 - ▷ DME/GPS holds – fly the outbound leg to the specified distance from the fix/waypoint.

HOLDING SPEEDS

- May be restricted to 175 kts on some instrument approach procedures

Altitude (MSL)	Max airspeed (kts)
6,000' or below	200 kts
6001 - 14,000	230 kts
14,001 and above	265 kts
Air Force fields	310 kts *
Navy Fields	230 kts *

* Unless published otherwise.

HOLDING ENTRY

Direct - Upon crossing the fix turn to follow the holding pattern

Parallel - Upon crossing the fix, turn to a heading parallel to the holding course outbound for 1 minute. Then turn into the hold pattern to intercept the inbound course.

Teardrop - Upon crossing the fix, turn outbound to a heading 30° into the pattern. Fly it for 1 minute, then turn in the direction of the hold turns to intercept the inbound course.

AT THE HOLD FIX, REPORT TO ATC:

“[Callsign] Over [place] [altitude] at [time]”

LOST COMMUNICATIONS PROCEDURE §91.185

If in VFR conditions, continue the flight under VFR and land as soon as practicable, otherwise:

Altitude to fly	Route to fly
<p>The highest of: “MEA” –</p> <ul style="list-style-type: none"> ■ M - Minimum altitude prescribed for IFR ■ E - Expected (as in: “Expect 5000 10 min after departure”) ■ A - Assigned. Last altitude assigned by ATC. <p>* Highest for the route segment flown</p>	<p>Select the route by This order: “AVEF” –</p> <ul style="list-style-type: none"> ■ A - Assigned route, or, if none: ■ V - Vectored (fly to fix/route/airway last vectored to), if none: ■ E - Last Expected route by ATC, if none: ■ F - Filed route

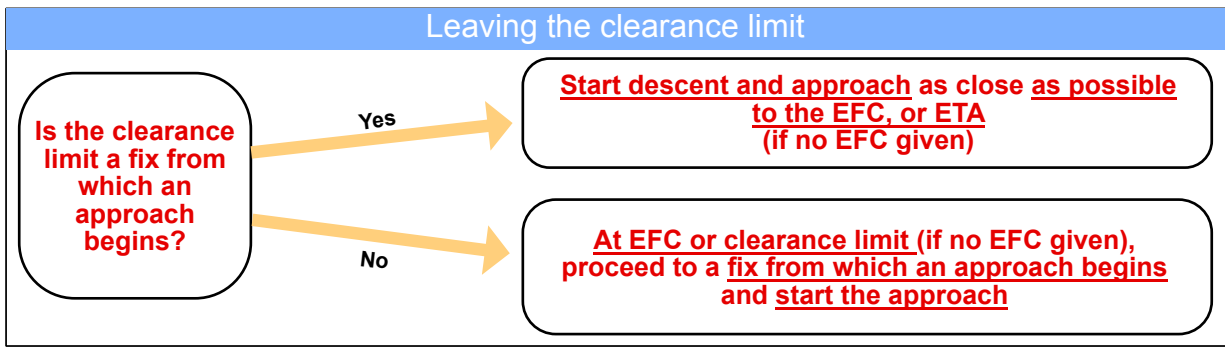

PROCEDURE TURN

§91.175, AIM 5-4-9

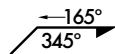

- A PT is a maneuver that enables:
 - ▷ Course reversal.
 - ▷ A descent from IAF.
 - ▷ Inbound course interception.
- Max speed - 200 kts.
- Remain within the charted distance (“Remain within _ NM” note), typically 10 NM, and comply with published altitudes for obstacle clearance.
- The shape of the maneuver is mandatory if a teardrop or holding-in-lieu of a PT is published. Otherwise, only the direction of the turn is mandatory.
- A teardrop procedure may be published in lieu of a PT. In that case:
 - ▷ No IF published? Intermediate segment begins 10 miles prior to the final approach fix.
 - ▷ Nav facility located on the airport? Final approach starts at completion of the teardrop turn. However, the final approach segment begins on the final approach course 10 miles from the facility.
- A PT or hold-in-lieu-of-PT is mandatory when depicted on the approach chart. However, it is not permitted when: “NoPT” depicted on the chart, when receiving radar vectors to final or when conducting a timed approach from a holding fix.

Do not fly a procedure turn when: “SHARP TT” –

- Straight-in approach clearance.
- Holding in lieu of a procedure turn.
- DME Arc.
- Radar vectors to final.
- No PT depicted on chart.
- Timed approach from a hold fix.
- Teardrop course reversal.

INSTRUMENT APPROACHES

- **Precision**
Lateral + vertical guidance to a DA.
 - ▷ ILS - Instrument Landing System
 - ▷ PAR - Precision Approach Radar
 - ▷ GLS - GBAS Landing System
- **Non-Precision**
lateral guidance only. Flown to MDA.
 - ▷ VOR
 - ▷ NDB
 - ▷ RNAV / RNP to LNAV or LP Minima
 - ▷ LOC - Localizer
 - ▷ LDA - Localizer-type Directional Aid. Identical to a LOC but not aligned with the runway.
 - ▷ SDF - Simplified Directional Facility. Similar to a LOC with 6° or 12° width. May be aligned or not with the runway.
 - ▷ ASR - Approach Surveillance Radar
- **Approach with Vertical Guidance (APV).**
A precision-like approach, flown to a DA with lateral + vertical guidance, but does not meet precision approach standards.
 - ▷ RNAV / GNSS (i.e. LNAV/VNAV and LPV minima)
 - ▷ LDA with Glide Slope

Approach Clearances

- When can you descend to the next instrument approach segment?
 - ▷ When cleared for the approach and established on a segment of a published approach or route. (AIM 5-5-4)
- Contact approach (AIM 5-5-3)
 - ▷ Requested by the pilot in lieu of an instrument approach. (Cannot be initiated by ATC)
 - ▷ Requires at least 1SM ground visibility and remain clear of clouds.
 - ▷ Only at airports with approved instrument approach procedures.
 - ▷ Pilot assumes responsibility for obstruction clearance.
- Visual approach (AIM 5-5-11)
 - ▷ Initiated by ATC or the pilot.
 - ▷ Requires at least **1000' ceiling and 3SM visibility.** (IFR in VMC)
 - ▷ Pilot must have either the airport or the traffic to follow in sight.
 - ▷ Pilot is responsible for visual separation from traffic to follow.

Missed Approach (AIM 5-5-5)

- Execute a missed approach when:
 - ▷ Arrival at MAP or DH with insufficient visual reference to runway environment.
 - ▷ A safe approach is not possible.
 - ▷ Instructed to do so by ATC.

When can you descend below MDA / DA? (§91.175)

1. The aircraft is **continuously in a position** from which **a descent to a landing on the intended runway** can be made at a **normal rate of descent using normal maneuvers**.
2. The **flight visibility** (or the enhanced flight visibility, if equipped) is **not less than the visibility prescribed in the standard instrument approach** being used.
3. **At least one** of the following **visual references** for the intended runway is **distinctly visible and identifiable to the pilot:** (except for CAT II & III approaches)
 - i. The **approach light system**, except that **the pilot may not descend below 100 feet above the touchdown zone elevation using the approach lights as a reference unless the red terminating bars or the red side row bars are also distinctly visible and identifiable**.
 - ii. The **threshold**.
 - iii. The **threshold markings**.
 - iv. The **threshold lights**.
 - v. The **runway end identifier lights**.
 - vi. The **visual glideslope indicator**.
 - vii. The **touchdown zone or touchdown zone markings**.
 - viii. The **touchdown zone lights**.
 - ix. The **runway or runway markings**.
 - x. The **runway lights**.

VISUAL DESCENT POINT (VDP) (AIM 5-4-5)

- A defined point on the final approach course of a **non-precision straight-in approach** procedure from which **normal descent from the MDA to the runway touchdown point may begin**, provided adequate visual reference is established.
- Identified by a 'V' symbol on the descent profile.
- If not equipped to identify the VDP, fly the approach as if no VDP was published.
- Do not descend below the MDA prior to reaching the VDP.
- **Calculate VDP**, when not published: **By distance: VDP (in NM from threshold) = MDH / 300**

Example: Given MDH is 600 ft, **how far** is the VDP from the threshold?

$$\text{VDP} = 600 / 300 = 2 \text{ NM}$$

Start the descent 2 NM from the threshold.

$$\text{By time: MDH} / 10 = \text{seconds to subtract from time between FAF and MAP}$$

Example: Given MDH is 500 ft, FAF to MAP is 4:00, **when** would you be over the VDP and start the descent from MDA/H?

$$500 / 10 = 50 \text{ seconds. } 4:00 - 0:50 = 3:10$$

Start the descent at 3:10 (time from FAF)

VERTICAL DESCENT ANGLE (VDA) (AIM 5-4-5)

- A computed glide path from the FAF to the runway's TCH published for non-precision approaches. Typically 3°.
- FAA policy is to publish a VDA/TCH on all non-precision approaches except those published in conjunction with vertically guided minimums (i.e., ILS or LOC RWY XX) or no FAF procedures without a stepdown fix (i.e., on-airport VOR or NDB). A VDA does not guarantee obstacle protection below the MDA in the visual segment. The presence of a VDA does not change any non-precision approach requirements.
- VDAs are **advisory only**, pilots must still **comply with all published altitudes** on the procedure.

Rate of Descent for a 3° Glide Path

$$\text{VS (fpm)} = \text{Ground Speed} \times (10 / 2), \text{ or}$$

$$\text{VS (fpm)} = \text{Ground Speed} \times 5$$

Example:

$$120 \text{ kts} \times (10 / 2) = 120 \text{ kts} \times 5 = 600 \text{ fpm}$$

How Far to Start a Descent for a 3° Glide Path?

$$\text{TOD} = \text{Altitude to lose (ft)} / 300$$

Example, on approach

800 ft to lose MDA to TCH:

$$800 / 300 = 2.67 \text{ NM}$$

Start descent 2.67 NM from the runway threshold.

Example

Cruising at FL350, ATC: "...cross LGA VOR at FL240":

$$\text{Altitude to lose} = 35,000 - 24,000 = 11,000 \text{ ft}$$

$$11000 / 300 = 36.67 \text{ NM}$$

Start descent 36.67 NM from LGA VOR

Other Glide Path Angles

$$\text{Descent gradient (\%)} = \tan(\text{descent angle}) \times 100$$

Descent angle	Gradient (%) = tan(angle)
2°	3.5%
3°	5.2%
4°	7%
5°	8.7%

$$\text{VS (fpm)} = \text{Groundspeed} \times \text{Descent Gradient (\%)}$$

$$\text{TOD} = \text{Altitude to lose} / (\text{glidepath angle} * 100)$$

Example

At FL350, ATC: "...cross LGA VOR at FL240", pilot elects a steep 4° slope, 380 kts GS:

$$\text{VS} = 380 \times 7 = 2660 \text{ fpm}$$

$$\text{TOD} = 11000 / 400 = 27.5 \text{ NM}$$

Start the descent 27.5NM from LGA at 2800 fpm

AIRSPACE

Class A (AIM 3-2-2)

- **Controlled** airspace from 18,000' MSL to FL600 within the 48 contiguous states and Alaska. Includes the airspace within 12 NM of the shoreline as well as designated international airspace beyond the 12 NM distance.
- IFR only unless otherwise authorized.

Class B (AIM 3-2-3, §91.131)

- **Controlled airspace** surrounding the nation's **busiest airports**.
- Usually extends from the surface up to 10,000' MSL.
- The shape of each class B is specifically tailored for its environment.
- Consist of a surface area and two or more layers (resembling an upside-down wedding cake).
- Requires two-way radio communications.
- ATC separates both VFR and IFR traffic.
- Requires ATC clearance to enter. VFR pilots must make sure they hear a clearance to "Enter Class B". IFR pilots will typically already have this clearance as part of their ATC clearance picked up before or after takeoff.
- A Mode-C transponder and ADS-B Out equipment are required within a 30 NM radius (the "Mode-C Veil").

Class C (AIM 3-2-4)

- **Controlled airspace** around towered airports with certain number of IFR operations or passenger volume.
- Typical inner area is a 5 NM radius surrounding its primary airport, extending up to 4,000' above airport height.
- A 10 NM radius shelf area typically extends from no lower than 1,200' up to 4,000' above airport height.
- A non-charted outer area extends up to 20 NM from the primary airport.
- ATC Provides VFR/ IFR traffic separation in the outer area if two-

way radio communication is established and in the Class C airspace itself.

- Requires two-way radio communication, a Mode-C transponder and ADS-B Out equipment.

Class D (AIM 3-2-5)

- Controlled airspace extending from the surface to 2,500' above airport height.
- Usually shaped as a cylinder with a 4 NM radius from the primary airport.
- Requires two-way radio communication.

Class E (AIM 3-2-6)

- **Controlled airspace** not designated as A, B, C, or D.
- May or may not be associated with an airport.
- Requires Mode-C transponder and ADS-B Out equipment at and above 10,000' MSL within the 48 contiguous states and D.C, excluding at or below 2,500' AGL.
- Requires ADS-B Out at and above 3,000' MSL over the Gulf of Mexico from the U.S. coast out to 12 NM.

Functions of Class E:

- ▷ Surface area designated for an airport.
- ▷ Extension to a surface area of Class B, C, or D.
- ▷ Transition area. Begins at 700' or 1200' AGL used to transition to/from a terminal or en-route environment.
- ▷ En-route domestic areas
- ▷ Federal Airways / Low Altitude RNAV Routes
- ▷ Offshore Airspace Areas

Class G (AIM 3-3)

- **Uncontrolled airspace.** Class G airspace is generally any airspace that has not been designated as Class A, B, C, D, or E.

BASIC VFR WEATHER MINIMUMS §91.155

*** Minimum visibility & distance from clouds mnemonics:**
3152 – 3SM, 1000' above, 500' below, 2000' horizontal.
1152 – 1SM, 1000' above, 500' below, 2000' horizontal.
5111 – 5SM, 1000' above, 1000' below, 1SM horizontal.

Class A: IFR only

Class E at or above 10,000' MSL & Class G at / above 10,000' MSL & 1,200' AGL:
5111 *

Class E below 10,000' MSL: 3152 *

Class G above 1,200' AGL but below 10,000' MSL: Day: 1152 * Night: 3152 *

Class G at or below 1,200' AGL:
Day: 1 SM clear of clouds
Night: 3152 * or 1SM Clear of Clouds if in a traffic pattern within ½ SM from a runway.

Surface

- When the cloud ceiling is less than 1,000 feet, no person may operate an aircraft beneath the ceiling under VFR within the lateral boundaries of controlled airspace designated to the surface for an airport. Except under Special VFR (SVFR- §91.157).
- **Minimum ground visibility for landing, takeoff, or entering a traffic pattern at an airport within the lateral boundaries of Class B, C, D, or E surface areas is 3 SM.** If ground visibility is not reported, use flight visibility. (Except under Special VFR, §91.157).
- For the purpose of §91.155, **an aircraft operating at the base altitude of a Class E airspace area is considered to be within the airspace directly below that area.**

SPECIAL USE AIRSPACE

Prohibited Areas (§91.133, AIM 3-4-2)

- **Flight is prohibited** unless permission is granted by the using or controlling agency, as appropriate.
- Prohibited airspace exists due to security or other reasons associated with the national welfare.
- Example: Prohibited airspace P-56A over the White House.

Restricted Areas (§91.133, AIM 3-4-3)

- Flight is **not completely prohibited, but is subject to restrictions** due to **hazards to aircraft** such as artillery firing, aerial gunnery, or guided missiles.
- No person may operate an aircraft within a restricted area contrary to the restrictions imposed, unless that person has the permission of the using or controlling agency.
- If the restricted airspace is **not active** and has been released to the controlling agency (FAA), **ATC will allow the aircraft to operate in the restricted airspace without a specific clearance to do so.**
- If the restricted airspace is **active**, and has not been released to the controlling agency (FAA), **ATC will issue a clearance which will ensure the aircraft avoids the restricted airspace** unless it is on an approved altitude reservation mission or has obtained its own permission to operate in the airspace and so informs the controlling agency.

Warning Areas (AIM 3-4-4)

- Extends **3 NM outward from the coast of the U.S.**
- Contains **activity that may be hazardous** to aircraft.
- The purpose of warning areas is to warn nonparticipating aircraft of the potential hazard.
- May be located on domestic or international water, or both.

Military Operating Areas (MOA) (AIM 3-4-5)

- Established for the purpose of separating certain military training activities from IFR traffic.
- When a MOA is in use, nonparticipating IFR aircraft may be cleared through it if IFR separation can be provided. Otherwise, ATC will reroute or restrict the traffic.
- Example activities in an MOA: air combat tactics, air intercepts, aerobatics, formation training, and low-altitude tactics.
- Pilots operating under VFR should exercise extreme caution when operating within an active MOA. Therefore, pilots should contact any FSS within 100 miles of the area to obtain accurate real-time information concerning the MOA hours of operation. Prior to entering an active MOA, pilots should contact the controlling agency for traffic advisories.

Alert Areas (AIM 3-4-6)

- Depicted on charts to inform pilots of high volume of pilot training or an unusual type of aerial activity.
- Pilots transitioning the area are equally responsible for collision avoidance.

Controlled Firing Areas (AIM 3-4-7)

- Contain activities that, if not conducted in a controlled environment, may be hazardous to nonparticipating aircraft.

- Activities are suspended immediately when a spotter aircraft, radar or ground lookout positions indicate an aircraft might be approaching the area.

- CFAs are not charted because they do not cause a nonparticipating aircraft to change its flight path.

Military Training Routes (MTR) (AIM 3-5-2)

- IFR MTRs (IR) are typically above 1,500' AGL, while VFR MTRs (VR) are below 1,500' AGL.
- Generally, MTRs are established below 10,000 ft at speeds in excess of 250 knots. However, route segments may exist at higher altitudes.
- Route identification
 - ▷ MTRs with no segments above 1,500' AGL are identified by 4 digits; e.g., IR1206, VR1207.
 - ▷ MTRs that include one or more segments above 1,500' AGL are identified by three digits; e.g., IR206, VR207.

Air Defense Identification Zone (ADIZ) (AIM 5-6)

- An area of airspace over land or water, in which the ready identification, location, and control of all aircraft (except DoD and law enforcement aircraft) is required in the interest of national security.
- Requirements to operate within an ADIZ:
 - ▷ An operable Transponder with altitude encoding.
 - ▷ Two-way radio communication with the appropriate aeronautical facility.
 - ▷ File an IFR or Defense VFR (DVFR) Flight Plan.
 - ▷ Depart within 5 minutes of flight plan's estimated departure time (exempt in Alaska info facility exists for filing, file immediately after departure or when within range of an appropriate facility).

Temporary Flight Restrictions (TFR) (AIM 3-5-3)

- Defined in Flight Data Center (FDC) NOTAMS
- TFR NOTAMS begin with the phrase: "FLIGHT RESTRICTIONS."
- Current TFRs are found at: www.tfr.faa.gov.
- Some reasons the FAA may establish a TFR:
 - ▷ Protect persons or property in the air or on the surface from hazards by low flying aircraft.
 - ▷ Provide a safe environment for disaster relief aircraft.
 - ▷ Prevent an unsafe congestion of sightseeing aircraft around an event of high public interest.
 - ▷ Protect declared national disasters for humanitarian reasons in the State of Hawaii.
 - ▷ Protect the President, Vice President, or other public figures.
 - ▷ Provide a safe environment for space agency operations.

Special Flight Rules Area (SFRA) (AIM 3-5-7)

- An airspace of defined dimensions above land areas or territorial waters, where special air traffic rules have been established for.
- Each person operating in a SATR (Special Air Traffic Rules) or SFRA must adhere to the special air traffic rules in 14 CFR Part 93, unless otherwise authorized or required by ATC.
- Example: The Washington DC Metropolitan SFRA.

MAX AIRCRAFT AIRSPEEDS IN THE U.S. §91.117

- **Mach 1.0** (speed of sound): above 10,000' MSL. (§91.817)
 - **250 kts**: below 10,000' MSL.
 - **200 kts**: under Class B, or within a VFR corridor through Class B.
 - **200 kts**: at or below 2,500' within 4 NM of the primary airport of a Class C or D airspace.
 - **If the aircraft minimum safe airspeed for any particular operation is greater than the max speed prescribed above, the aircraft may be operated at that minimum speed.**
-

WEATHER**WEATHER INFORMATION SOURCES**

- **Flight Service Station (FSS)**
- **NOAA's Aviation Weather Center Website**
<https://www.aviationweather.gov/>
- Flight planning websites such as www.1800wxbrief.com and www.fltplan.com
- EFB software (i.e., ForeFlight, Jeppesen FlightDeck Pro)
- **Flight Information Services-Broadcast (FIS-B)** – A ground information data link service, provided through the **ADS-B** service network over 978 UAT MHz. Provides aviation weather and aeronautical information on cockpit displays. Some information available on FIS-B:
 - ▷ METAR, TAF, NEXRAD, AIRMET, SIGMETs and convective SIGMETs
 - ▷ TFR, Special Use Airspace updates and NOTAMs (FDC and distant)
 - ▷ PIREPs
- **Automatic Terminal Information Service (ATIS)** – A continuous broadcast of local airport weather and NOTAMs. Updated hourly, normally at 55 minutes past the hour. Special updates issued outside the regular hourly cycle when needed. ATIS is published over the radio and, in locations with D-ATIS, via data link (ACARS).
- **Automated Surface Observation System (ASOS)** – Typically update hourly
- **Automated Weather Observation System (AWOS)** – Update every minute
- **ATC** - Center weather advisories are issued by ARTCC to alert pilots of existing or anticipated adverse weather conditions. ARTCC will also broadcast severe forecast alerts (AWW), convective SIGMETs and SIGMETs on all of its frequencies except for the emergency frequency (121.5 MHz).
- **Onboard weather radar**
- **Onboard lightning detector**
- **XM Satellite weather service**
- **ACARS**

TYPES OF WEATHER BRIEFINGS

- **Standard** – A full briefing. Includes: adverse conditions, VFR not recommended, synopsis, current conditions, enroute forecast, destination forecast, winds aloft, NOTAMs and ATC delays.
- **Abbreviated** – Updates previously received information from mass disseminated sources or a previous briefing.
- **Outlook** – For departures 6 or more hours away. Includes forecasts for the time of the flight.
- **Inflight** – FSS also provides any of the above types in flight.

WEATHER PRODUCTS

- **AIRMET (WA)** –
 - ▷ An advisory of **significant weather phenomena at lower intensities than those which require the issuance of SIGMETs**. These conditions may affect all aircraft but are potentially hazardous to aircraft with limited capability.
 - ▷ **Valid for 6 hours.**
 - ▷ **AIRMET (T)** - describes **moderate turbulence, sustained surface winds of 30 knots or greater, and/or non-convective low-level wind shear.**
 - ▷ **AIRMET (Z)** - describes **moderate icing** and provides freezing level heights.
 - ▷ **AIRMET (S)** - describes **IFR conditions** and/or extensive **mountain obscurations.**
 - ▷ **Graphical AIRMETs** (AIRMET G) – found at www.aviationweather.gov
- **SIGMET (WS)** –
 - ▷ A **non-scheduled inflight advisory** with a **maximum forecast period of 4 hours**. Advises of non-convective weather potentially hazardous to all types of aircraft. A SIGMET is issued when the following is expected to occur:
 - ▷ **Severe icing not associated with thunderstorms**
 - ▷ **Severe or extreme turbulence or Clear Air Turbulence (CAT) not associated with thunderstorms.**
 - ▷ **Dust storms, sandstorms** lowering surface visibility below 3 miles.
- **Convective SIGMET (WST)** –
 - ▷ An **inflight advisory of convective weather significant** to the safety of **all aircraft**.
 - ▷ Issued **hourly at 55 minutes** past the hour for the **western (W), eastern (E) and central (C) USA**.
 - **Not issued for Alaska or Hawaii.**
 - ▷ **Valid for 2 hours.**
 - ▷ Contains either an **observation and a forecast or only a forecast.**
 - ▷ **Issued for any of the following:**
 - **Severe thunderstorms** due to:
 - **Surface winds greater or equal to 50 knots**
 - **Hail at the surface greater than 3/4 inch in diameter**
 - **Tornadoes**
 - **Embedded thunderstorms** of any intensity level
 - A **line of thunderstorms** at least **60 miles long** with thunderstorms affecting at least **40% of its length.**

Weather Products - Continued

- Thunderstorms producing **heavy or greater precipitation (VIP level 4)** affecting **at least 40% of an area of at least 3000 square miles**.
 - ▷ **Any Convective SIGMET implies severe or greater turbulence, severe icing, and low level wind shear.**
- **International SIGMET**
 - ▷ Issued **outside the Contiguous USA** and **follow ICAO coding standards**.
 - ▷ In the US, international SIGMETs are **issued for areas that include Alaska, Hawaii, portions of the Atlantic and Pacific Oceans, and the Gulf of Mexico**.
 - ▷ Criteria for international SIGMETs:
 - **Thunderstorms** occurring in lines, **embedded in clouds**, or in large areas producing **tornadoes or large hail**.
 - **Tropical cyclones**
 - **Severe icing**
 - **Severe or extreme turbulence**
 - **Dust storms and sandstorms** lowering surface **visibility to less than 3 miles**
 - **Volcanic ash**
- **PIREP (UA) & Urgent PIREP (UUA)** – pilot weather reports.
- **METAR** – Aviation routine weather show surface weather observations in a standard international format. Scheduled METARs are published every hour. Non-scheduled METARs (**SPECI**) are issued when there is a significant change in one or more reported element since the last scheduled METAR.
- **TAF** – Terminal Aerodrome Forecast. Weather forecast for 5SM radius area around the station. Issued 4 times a day, every six hours and normally covers a 24 or 30 hour forecast period. TAF amendments (TAF **AMD**) supersede previous TAFs.
- **Surface analysis chart** –Generated from surface station reports. Shows pressure systems, isobars, fronts, airmass boundaries (e.g.: dry lines and outflow boundaries) and station information (e.g.: wind, temperature/dew point, sky coverage, and precipitation). Issued every 3 hours. (or every 6 hours in Hawaii and tropical and Oceanic regions). A **Unified Surface Analysis Chart** is produced every 6 hours and combines the analysis from the 4 centers (OPC, WPC, NHC and HFO)
- **Radar summary chart (SD)** – Depicts precipitation type, intensity, coverage, movement, echoes, and maximum tops. Issued hourly
- **Wind & temp aloft forecasts (FB)** – Issued 4 times daily for various altitudes and flight levels. Winds at altitude up to 1500' AGL and temperatures at up to 2500' AGL are not shown. **Format: DDff±tt**, where DD = wind direction; ff = wind speed; t = temperature. Light and variable winds: 9900. Winds between 100-199 Kt are coded by adding 5 to the first digit of the wind direction. Above FL240 temperatures are negative and the minus sign (-) is omitted. **Examples:**
1312+05: winds 130 / 12 kts, 5°C.
7525-02: winds 250 / 125 kts, -2° C.
- **Low level significant weather chart** – Forecasts significant weather conditions for a 12 and 24 hour period from the surface to 400 mb level (24,000 ft). Issued 4 times a day. Depicts weather categories (IFR, MVFR and VFR), turbulence and freezing levels.
- **Mid-level significant weather chart** – Forecasts of significant weather at various altitudes and flight levels from 10,000' MSL to FL450. Shows: thunderstorms, jet streams, tropopause height, tropical cyclones, moderate and severe icing conditions, moderate or severe turbulence, cloud coverage and type, volcanic ash and areas of released radioactive materials. Issued 4 times a day for the North Atlantic Region.
- **High-level significant weather charts** – Depicts forecasts of significant weather phenomena for FL250 to FL630. Shows: coverage bases and tops of thunderstorms and CB clouds, moderate and severe turbulence, jet streams, tropopause heights, tropical cyclones, severe squall lines, volcanic eruption sites, widespread sand and dust storms. Issued 4 times a day.
- **Convective outlook (AC)** – Available in both graphical and textual format. A 3-day forecast of convective activity. Convective areas are classified as marginal (MRGL), slight (SLGT), enhanced (ENH), moderate (MDT), and high (HIGH) risk for severe weather. Issuance: day 1 – 5 times a day, day 2 – twice a day, day 3 – once a day. Available on www.spc.noaa.gov.
- **Weather satellite** images:
 - ▷ **Visible**
 - Helps in identifying cloud coverage based on visible light reflection.
 - Not useful for identifying cloud height.
 - ▷ **Infrared** (Color or B/W)
 - Measure cloud top temperature
 - Highest clouds appear bright white.
 - Middle clouds are in shades of gray
 - Low clouds and fog are dark gray,
 - ▷ **Water vapor**
 - Shows areas of moist and dry air in shades of gray from white to black.
 - Moist air areas are depicted as bright white
 - Dry air is depicted in black.
- **Next Generation Weather Radar (NEXRAD)** products. Examples:
 - ▷ **Base reflectivity** - echo intensities in dBZ. Available for several elevation tilt angles.
 - ▷ **Echo tops** - color coded echo top heights.
 - ▷ **Composite reflectivity** - Reveals highest reflectivity of all echos, helps in examining storm structure features and the intensity of storms.
 - ▷ **1 and 3-hour precipitation**
- **Ceiling & Visibility Charts**- Shows ceiling based on surface observations. This online tool phased out the older weather depiction chart and is now replaced with the HEMS tool at www.aviationweather.gov/hemst
- **Graphical turbulence Guidance (GTG)** tool at www.aviationweather.gov/turbulence/gtg – Shows color coded turbulence forecast based on aircraft category, altitude and time.

WEATHER HAZARDS

THUNDERSTORMS**The Three Conditions Required for the formation of Thunderstorms:**

1. Sufficient **water vapor** (moisture).
2. An **unstable temperature lapse rate**. Stability is the resistance of the atmosphere to upwards or downwards displacement. An unstable lapse rate allows any air mass displacement to further grow vertically.
3. An initial **uplifting force** (e.g., front passages, orographic lifting by topography, heating from below, etc.).

Three Stages in Thunderstorm Lifecycle:

1. **Cumulus** (3-5 mile height) – The lifting action of the air begins, growth rate may exceed 3000 fpm.
2. **Mature** (5-10 miles height) – Begins when precipitation starts falling from the cloud base. Updraft at this stage may exceed 6000 fpm. Downdrafts may exceed 2500 fpm. All **thunderstorm hazards are at their greatest intensity at the mature stage**.
3. **Dissipating** (5-7 miles height) – Characterized by strong downdrafts and the cell dying rapidly.

Thunderstorm Hazards:

- | | | | |
|----------------------|--------------------------------|--------------|------------------------------------|
| ■ Limited visibility | ■ Strong updrafts / downdrafts | ■ Hailstones | ■ Severe turbulence |
| ■ Wind shear | ■ Icing | ■ Heavy rain | ■ Lightning strikes and tornadoes. |

FOG

A cloud that begins within 50 ft of the surface.

Fog occurs when:

- The air **temperature near the ground reaches its dew point**, or
- when the **dew point is raised to the existing temperature** by **added moisture** to the air.

Types of fog

- **Radiation fog** – Occurs at calm, clear nights when the ground cools rapidly due to the release of ground radiation.
- **Advection fog** – Warm, moist air moves over a cold surface. Winds are required for advection fog to form.
- **Ice fog** – Forms when the temperature is much below freezing and water vapor turns directly into ice crystals. Ice fog is common in the arctic regions, but also occurs in mid-latitudes.
- **Upslope fog** – Moist, stable air is forced up a terrain slope and cooled down to its dew point by adiabatic cooling.
- **Steam fog** – Cold, dry air moves over warm water. Moisture is added to the airmass and steam fog forms.

ICING

- **Structural ice**. Two conditions for formation: **1. Visible moisture** (i.e., rain, cloud droplets), and **2. Aircraft surface temperature below freezing**.
 - ▷ **Clear ice**– The most dangerous type. Heavy, hard and difficult to remove. Forms when water drops freeze slowly as a smooth sheet of solid ice. Usually occurs at temperatures close to the freezing point (-10° to 0° C) by large supercooled drops of water
 - ▷ **Rime ice** – Opaque, white, rough ice formed by small supercooled water drops freezing quickly. Occurs at lower temperatures than clear ice.
 - ▷ **Mixed ice** – Clear and rime ice formed simultaneously.
- **Instrument ice** – Structural ice forming over aircraft instruments and sensors, such as pitot and static.
- **Induction ice** – ice reducing the amount of air for the engine intake.
- **Intake ice** – Blocks the engine intake.
- **Carburetor ice** – May form due to the steep temperature drop in the carburetor Venturi. Typical conditions are outside air temperatures of -7° to 21° C and a high relative humidity (above 80%).
- **Frost** – Ice crystals caused by deposition when both the temperature and the dew point are below freezing.

AEROMEDICAL (Pilot Handbook of Aeronautical Knowledge)

- **Hypoxia** - Insufficient supply of oxygen to the body cells.
 - ▷ **Hypoxic hypoxia** – Insufficient supply of O₂ to the body as a whole. As altitude increases, O₂ percentage of the atmosphere is constant, but its pressure decreases. The reduced pressure becomes insufficient for the O₂ molecules to pass through the respiratory system's membranes.
 - ▷ **Hypemic hypoxia** – Inability of the blood to carry the O₂ molecules. It may be a result of insufficient blood (bleeding or blood donation), anemia or CO poisoning.
 - ▷ **Histotoxic hypoxia** – Inability of the body cells to affectively use the O₂ supplied by the blood. This can be caused by use of alcohol or drugs.
 - ▷ **Stagnant hypoxia** - Caused by the blood not flowing efficiently. Can be caused by heart problems, excessive acceleration (Gs), shock or a constricted blood vessel. Cold temperatures can restrict circulation and decrease blood supplied to the extremities.
- **Hyperventilation** – A condition which occurs when excessive amount of CO₂ is eliminated from the body as a result of breathing too rapidly. Symptoms may be similar to those of hypoxia. Breathing into a paper bag or talking aloud helps recovery from hyperventilation.
- **Decompression sickness** – Inert gasses (mainly nitrogen) are released rapidly from solution in the body tissues and fluids as a result of low barometric pressure. The gasses form bubbles that may harm the body in several ways. The most common result of decompression sickness is joint pain (“the bends”). To help prevent the bends after SCUBA diving: **wait at least 12 hours after diving that does not require a controlled ascent (non-decompression stop diving) for flights up to 8000 ft MSL; wait 24 hours for flights above 8000 ft or after any diving that required a controlled ascent (decompression stop diving).**

Oxygen requirements (§91.211, Note: see §121.327-121.333 & §135.89, §135.157 for 121/135 operations O₂ rules)

- **Unpressurized cabins**
 - ▷ Cabin pressure altitudes **above 12,500 to 14,000' MSL (including)** – The required minimum **flight crew must be provided with and must use supplemental O₂** for periods of flight over **30 minutes at these altitudes.**
 - ▷ Cabin pressure altitudes **above 14,000'** – The required minimum **flight crew must be provided with and must use supplemental O₂ the entire flight time at these altitudes.**
 - ▷ Cabin pressure altitudes above 15,000' MSL – Each occupant must be provided with supplemental O₂.
- **Pressurized cabins**
 - ▷ **Above FL250** - an addition of at least **10 minutes** of supplemental **O₂** for **each occupant** is required.
 - ▷ **Above FL350** - one pilot at the controls must wear and use an **O₂ mask unless two pilots are at the control with quick-donning masks and the aircraft is at or below FL410.**
 - ▷ **If one pilot leaves the controls above FL350, the other pilot must wear and use his O₂ mask regardless if it's a quick donning type.**
- **Middle Ear & Sinus blockage**
 - ▷ Air pressure in the middle ear and sinuses normally equalizes with external air through the nasal passages.
 - ▷ Allergies, colds or sinus infections may block these small opening and prevent the pressure from equalizing.
 - ▷ If the air gets trapped, it may cause extreme pain, reduction in hearing or damage to the ear drums. This effect is usually most severe during descent.
 - ▷ To relieve this condition, try the “**Valsalva Maneuver**”: pinch your nostrils and **gently** try to blow air out of your nose. This forces air through the Eustachian tube into the middle ear. It may not work if the pilot has a cold, sinus or ear infection, or a sore throat.
 - ▷ Consider seeing a physician if the condition doesn't clear after the flight.
- **Spatial disorientation and illusions**
 - ▷ 3 systems the body uses for spatial orientation
 - **Vestibular System** - Consists of organs in the inner ear
 - **3 semicircular canals** sense movement in 3 axes: **pitch, roll and yaw.** The canals are filled with fluid, which moves against tiny sensory hairs as the head is moved. The brain gets these signals and interprets a sensation of movement.
 - **2 otolith organs**, the utricle and saccule, sense **acceleration** in the horizontal and vertical planes.
 - **Somatosensory System** - Consists of nerves in the skin, muscles and joints.
 - **Visual System** - Visual cues from our eyes help the brain figure out spatial orientation.
 - ▷ **Vestibular Illusions**
 - **The leans** - After leveling the wings following a prolonged turn, pilot may feel that the aircraft is banked in the opposite direction of the turn.
 - **Coriolis Illusion** - After a prolonged turn, the fluid in the ear canal moves at same speed as the canal. A head movement on a different plane will cause the fluid to start moving and result in a false sensation of acceleration or turning on a different axis.
 - **Graveyard Spiral** - A pilot in a prolonged, coordinated constant-rate turn may experience the illusion of not turning. After leveling the wings, the pilot may feel the sensation of turning to the other direction (“the leans”), causing the pilot to turn back in the original direction. Since a higher angle of attack is required during a turn to remain level, the pilot may notice a loss of altitude and apply back force on the elevator. This may tighten the spiral and increase the loss of altitude.
 - **Somatogravic Illusion** - Rapid acceleration stimulates the inner ear otolith organs in the same way as tilting the head backwards. This may create the illusion of a higher pitch angle. Deceleration causes the opposite illusion – the sensation of tilting the head forward and the aircraft being in a nose-low attitude.
 - **Inversion Illusion** - An abrupt change from climb to straight and level may create the illusion of tumbling backwards due to the fluid movement in the otolith organs.
 - **Elevator Illusion** - An abrupt upward vertical acceleration may create the illusion of climbing, due to fluid movement in the otolith organs.

Spatial disorientation and illusions - continued

▷ **Visual Illusions**

- **False Horizon** - An illusion in which the pilot may misidentify the horizon line. May be caused by sloping cloud formation, an obscured horizon, an aurora borealis, dark night with scattered lights and stars or the geometry of the ground
- **Autokinesis** - Staring at a stationary point of light in a dark or featureless scene for a prolonged period of time may cause the light to appear to be moving. A pilot may attempt to align the aircraft with the perceived moving light, resulting in loss of control.

▷ **Optical Illusions**

- **Runway Width Illusion** - During approach to land, a narrow runway may give the pilot the illusion that the airplane is too high, whereas a wide runway may make it seem too low.
- **Runway and Terrain Slope Illusion** - An up-sloping terrain or runway can give the illusion that the plane is higher than it actually is.
- **Featureless Terrain Illusion** - Also known as “**black hole approach.**” Flying over dark or featureless terrain (for example, during an over-water approach) can give the illusion that the aircraft is at a higher altitude, causing the pilot to fly lower than desired.
- **Water Refraction** - Light refraction due to rain on the windshield may cause the horizon to seem lower and, as a result, the aircraft to appear higher. This illusion may lead the pilot to fly lower than desired.
- **Haze** - During an approach, haze may give the illusion that the runway is further or that the airplane is higher than it is.
- **Fog** - Flying into fog may create an illusion of a nose-up motion.
- **Ground Lighting Illusion** -
 - Lights along straight paths (e.g., road or train lights) can be mistaken for runway or approach lights.
 - Bright runway and approach lights can make the runway appear closer than it is, especially when the surrounding terrain is dark. This illusion may lead the pilot to fly a higher approach than desired.

Coping with spatial disorientation (Pilot Handbook of Aeronautical Knowledge)

1. Understand the causes of the illusions that may affect you as a pilot and stay alert for them when flying.
2. Obtain and understand relevant preflight weather information.
3. Maintain instrument proficiency and obtain training if needed before flying in marginal or instrument conditions.
4. Do not fly into adverse weather conditions or into dark or featureless areas unless instrument proficient.
5. When using outside visual references, ensure they are reliable, fixed points on the earth’s surface.
6. Avoid sudden head movements, particularly during takeoff, turns, and approaches to landing.
7. Be physically tuned for flight into reduced visibility. Ensure proper rest, adequate diet, and, if flying at night, allow for night adaptation. Remember that illness, medication, alcohol, fatigue, sleep loss, and mild hypoxia are likely to increase susceptibility to spatial disorientation.
8. Most importantly, **become proficient in the use of flight instruments and rely upon them. Trust the instruments and disregard your sensory perceptions.**

TABLES & REFERENCES

RNP Approach Minima – supported equipment					
Minima	GLS (DA)	LPV (DA)	LP (MDA)	LNAV / VNAV (DA)	LNAV (MDA)
Approach Type	Precision	APV	Non-precision	APV	Non-precision
GBAS (formerly LAAS)	✓	✓	✓	✓	✓
WAAS		✓	✓	✓	✓
GPS + Baro VNAV				✓	✓
Basic IFR GPS					✓

Tables & References - Continued

VOR Time & Distance
Distance off course = 200 ft per dot per NM from VOR
Distance to station = TAS X min between bearings / degrees of BRG change
Time (minutes) to station = Seconds of BRG change / degrees of BRG change

Transponder Codes	
Code	Description
7500	Aircraft hijacking
7600	Radio Failure
7700	Emergency

Standard Rate Turn - Angle of Bank Calculation
$(KTAS / 10) \times 1.5$
Example: 120 KTAS $(120 / 10) \times 1.5 = 12 \times 1.5 = 18^\circ$ of bank

RVR (ft)	Visibility (SM)
1,600	1/4
2,400	1/2
3,200	5/8
4,000	3/4
4,500	7/8
5,000	1
6,000	1-1/4

Aircraft Approach Categories		
CAT	1.3V _{so} (kts)	Standard (old) circling maneuver radius (NM)
A	< 90	1.3
B	91-120	1.5
C	121-140	1.7
D	141-165	2.3
E	> 165	4.5

Expanded Circling Approach Maneuvering Radius
 Identified by **C** on FAA approach charts.
 For procedures developed after late 2012. (AIM 5-4-20)

Circling MDA (MSL)	A	B	C	D	E
1000 or less	1.3	1.7	2.7	3.6	4.5
1001-3000	1.3	1.8	2.8	3.7	4.6
3001-5000 ft	1.3	1.8	2.9	3.8	4.8
5001-7000 ft	1.3	1.9	3.0	4.0	5.0
7001-9000 ft	1.4	2.0	3.2	4.2	5.3
9001 and above	1.4	2.1	3.3	4.4	5.5

Special VFR (SVFR) (91.157) –

An **ATC clearance** allowing operation under **VFR** with weather conditions lower than the standard VFR minimums prescribed in 91.155.

SVFR is available **below 10,000 MSL** within the airspace contained by the **upward extension of the lateral boundaries of the controlled airspace designated to the surface of an airport.**

Requires at least **1 SM** (as officially reported) and that the aircraft remains **clear of clouds.**

For **night SVFR** (sunset to sunrise), an **instrument rating** and **instrument-equipped aircraft** are required.

Flight Categories Used in AWC Weather Products				
Category	Color	Ceiling		Visibility
LIFR (Low IFR)	Magenta	Less than 500'	and/or	Less than 1 SM
IFR (Instrument Flight Rules)	Red	500' to below 1,000' ft AGL	and/or	1 SM to less than 3 SM
MVFR (Marginal VFR)	Blue	1,000'-3,000' AGL	and/or	3 to 5 SM
VFR (Visual Flight Rules)	Green	Greater than 3000' AGL	and	Greater than 5 SM

NOTES:
 By definition, IFR is ceiling less than 1,000' AGL and/or visibility less than 3 miles while LIFR is a sub-category of IFR.
 By definition, VFR is ceiling greater than or equal to 3,000' AGL and visibility greater than or equal to 5 SM while MVFR is a subcategory of VFR.
 Sources: <https://aviationweather.gov/taf/help?page=plot> and AIM 7-1-7

US TERMINAL PROCEDURES PUBLICATIONS LEGEND

RADIO AID SYMBOLS

110.1 Underline indicates No Voice transmitted on this frequency

Compulsory



Non-Compulsory



Marker beacons that are not specifically part of the procedure



Localizer Front Course



Localizer Back Course (Left-side shading)



SDF Course



LOC/LDA/SDF Transmitter (Shown when installation is offset from its normal position off the end of the runway)

Primary NAVAID with coordinate values

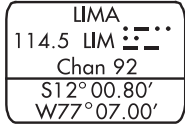

Secondary NAVAID

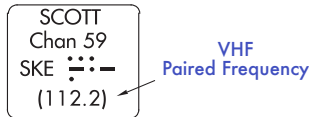
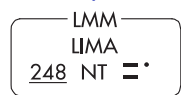

STAR/DP ROUTES

MAA FL200 Maximum Authorized Altitude

4500 MEA-Minimum Enroute Altitude

*3500 MOCA-Minimum Obstruction Clearance Altitude



Transition Route

R-275 Radial line and value

Lost communications Track

V12 J80 Airway/Jet Route Identification

ALTITUDES

5500 Mandatory Altitude 3000 Recommended Altitude

2500 Minimum Altitude 5000 Mandatory Block

4300 Maximum Altitude 3000 Altitude

INDICATED AIRSPEED

<u>175K</u>	<u>120K</u>	<u>250K</u>	180K
Mandatory Airspeed	Minimum Airspeed	Maximum Airspeed	Recommended Airspeed

HOLDING PATTERNS

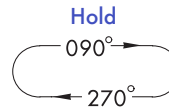

Hold

Hold-in-lieu of procedure turn

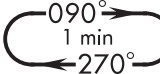

Missed approach

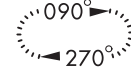

Lost Comm holding

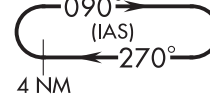
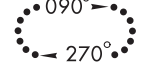

Holding pattern with max. restricted airspeed (175K) applies to all altitudes. (210K) applies to altitudes above 6000' up to and including 14000'.

TERMINAL ROUTES

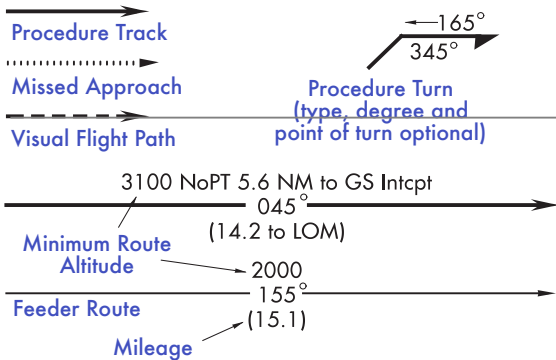

SPECIAL USE AIRSPACE



R - Restricted
P - Prohibited
MOA - Military Operations Area

W - Warning
A - Alert

AIRPORTS



Airports not served by the procedure are shown in screened color: [Screened symbols]

FIXES/ATC REPORTING REQUIREMENTS

▲ Fix-compulsory Position Report → DME Fix
 △ Non-compulsory Position Report

→ Obvious DME (DME mileage matches route mileage) → DME Mileage (When not obvious)

◆ WAYPOINT (Compulsory) ✦ WAYPOINT (Non Compulsory)

⊙ FLYOVER POINT

✕ Intersection ⊕ MAP WP (Flyover)

Computer Navigation Fix (CNF) - No ATC Function.
 X (CFMCC) ("x" omitted when in conflict with runway pattern)

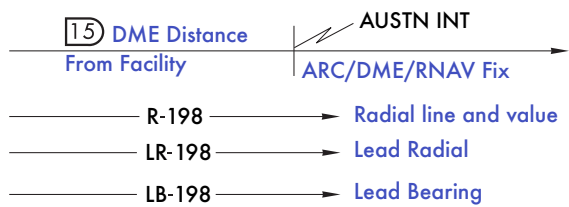

PLANVIEW OBSTACLES

- Spot elevation ● Highest spot elevation
- ▲ Obstacle ▲ Group of Obstacles
- △ Highest Obstacle ± Doubtful accuracy

MINIMUM SAFE ALTITUDE (MSA)

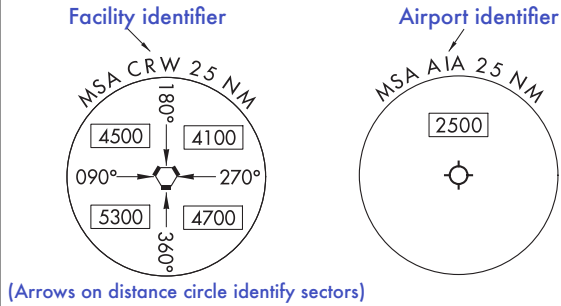

TERMINAL ARRIVAL AREA (TAA)

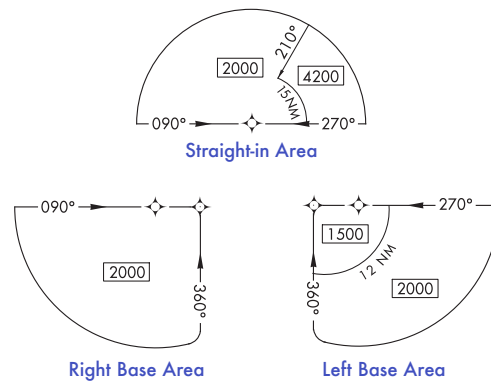

MISCELLANEOUS

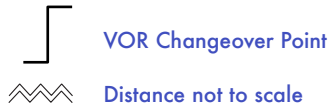

In this example airport elevation is 1179, and runway touchdown zone elevation is 1152.

CATEGORY	DA		HAT		Aircraft approach Category
	A	B	C	D	
S-ILS 27	1352/24		200	(200-½)	
S-LOC 27	1440/24	288	(300-½)		1440/50 288 (300-1)
CIRCLING	1540-1	1640-1	1640-1½	1740-2	
	361 (400-1)	461 (500-1)	461 (500-1½)	561 (600-2)	
	MDA	HAA	Visibility in Statute Miles		
COPTER MINIMA ONLY					
CATEGORY	COPTER				
H-176°	680-½		363	(400-½)	
	Copter Approach Direction		Height of MDA/DA		

No circling minima are provided

All weather minima in parentheses not applicable to Civil Pilot. Military Pilots refer to appropriate regulations.

PROFILE VIEW

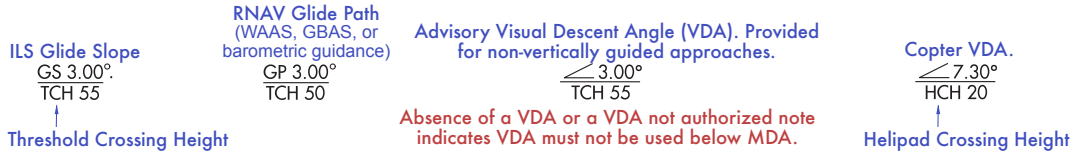

ILS or LOC APPROACH

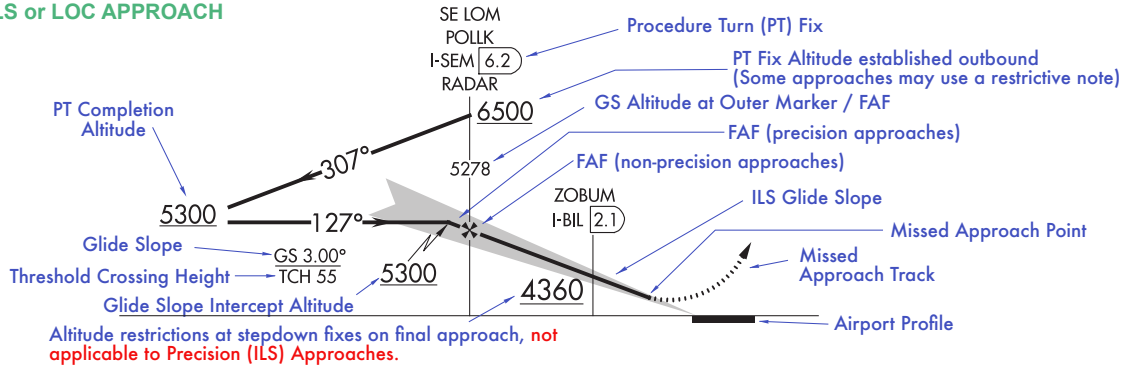

RNAV and GLS PROCEDURES WITH VERTICAL GUIDANCE

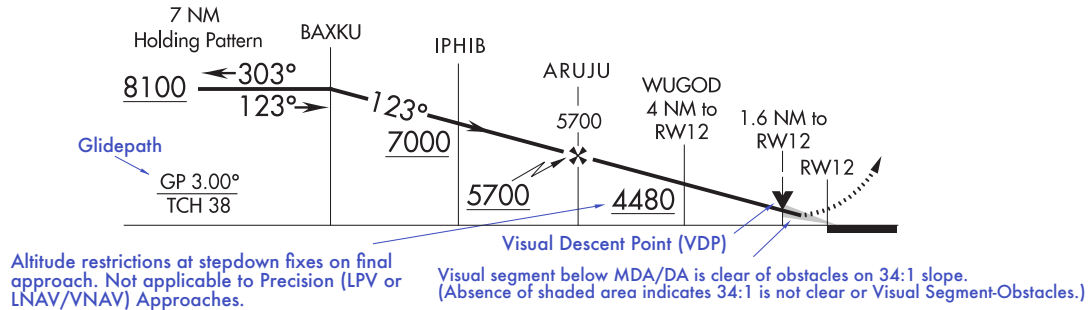

NON-VERTICALLY GUIDED PROCEDURES WITH MDA ONLY

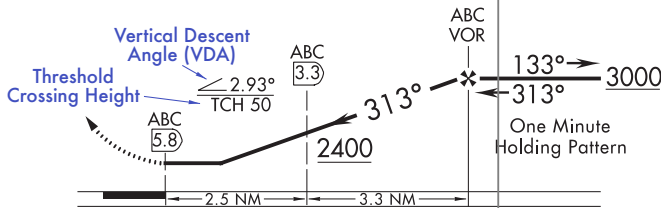

DESCENT FROM HOLDING PATTERN

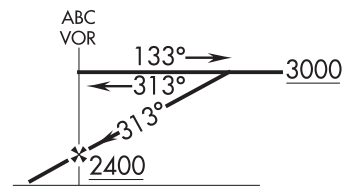

RNP APPROACH WITH TF AND RF SEGMENTS

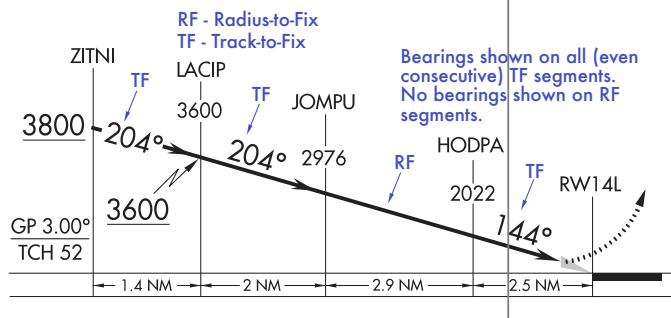

- * FAF for Non-Precision Approach (Maltese Cross symbol)
- ↘ Glideslope/Glidepath intercept altitude and FAF for Precision Approaches.
- ▼ Visual Descent Point (VDP)
- Solid vertical line: facilities & waypoints.
- - - Dashed vertical line: fixes & intersections.
- Visual Flight Path

APPROACH LIGHT SYSTEMS (ALS)

Legend

- Sequenced Flashing Lights** installed (indicated by the dot on the approach lighting identifier)
- Pilot Controlled Lights (PCL, indicated by a negative symbol)**
- Steady burning lights (green, red, white)
- Sequenced Flashing Lights
- Omni Directional Flashing Lights

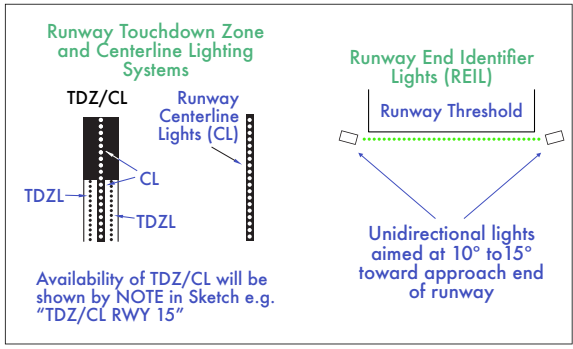
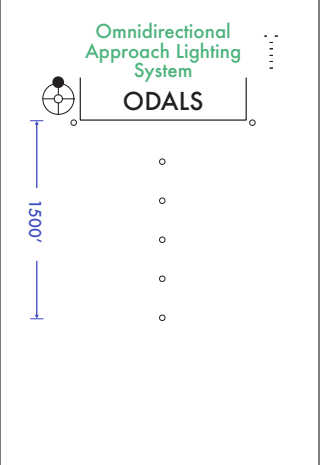
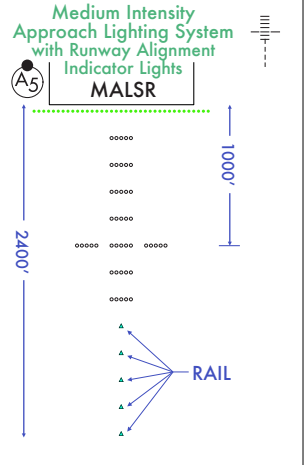
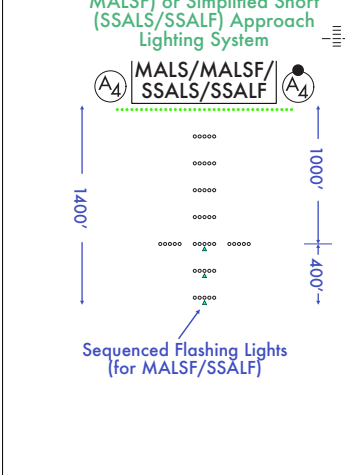
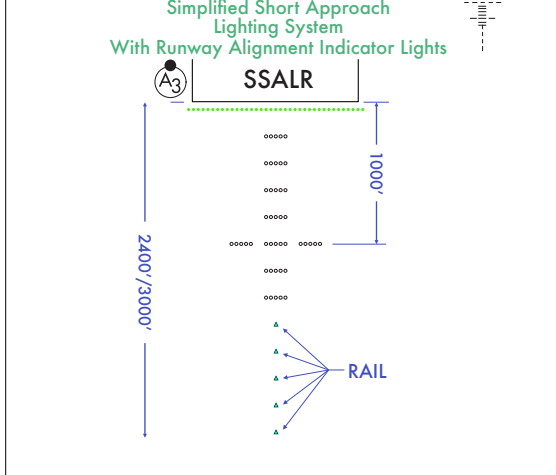
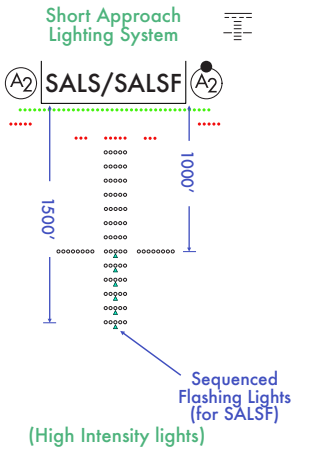
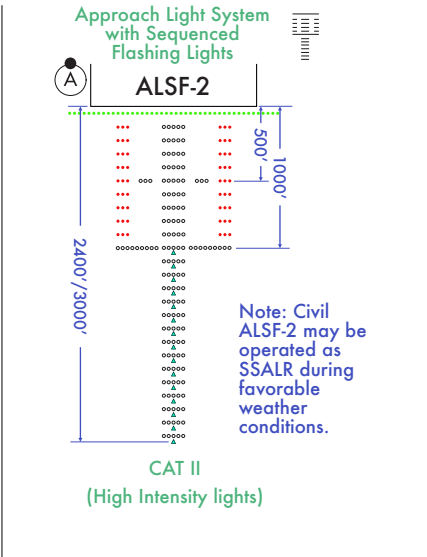
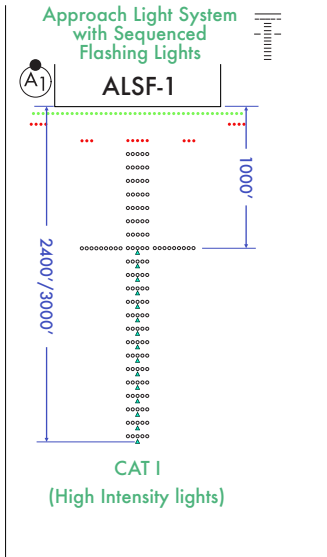

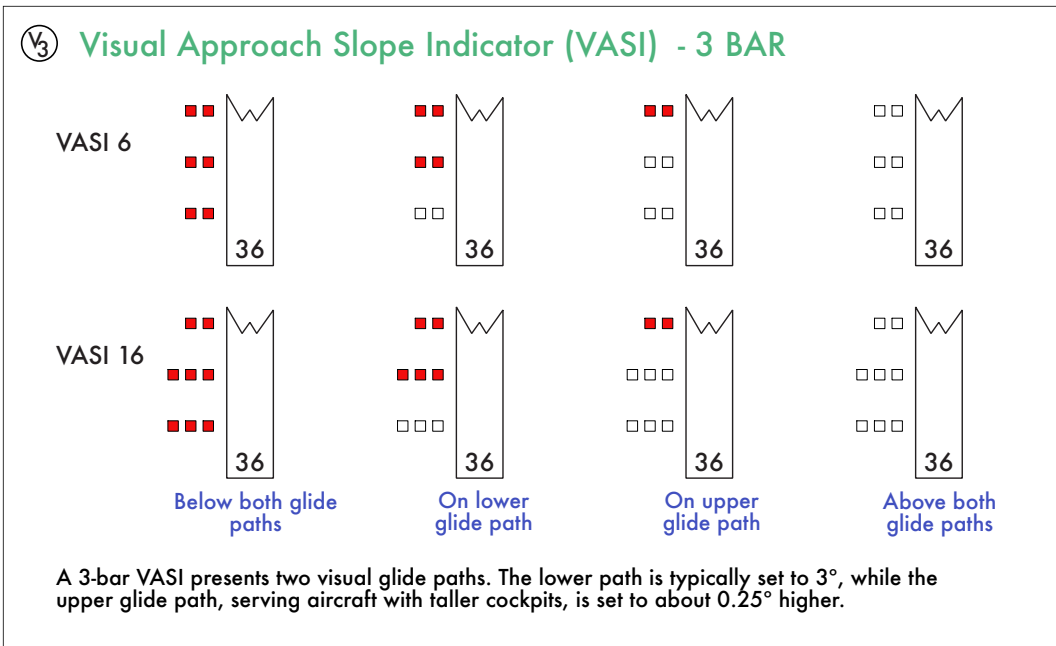
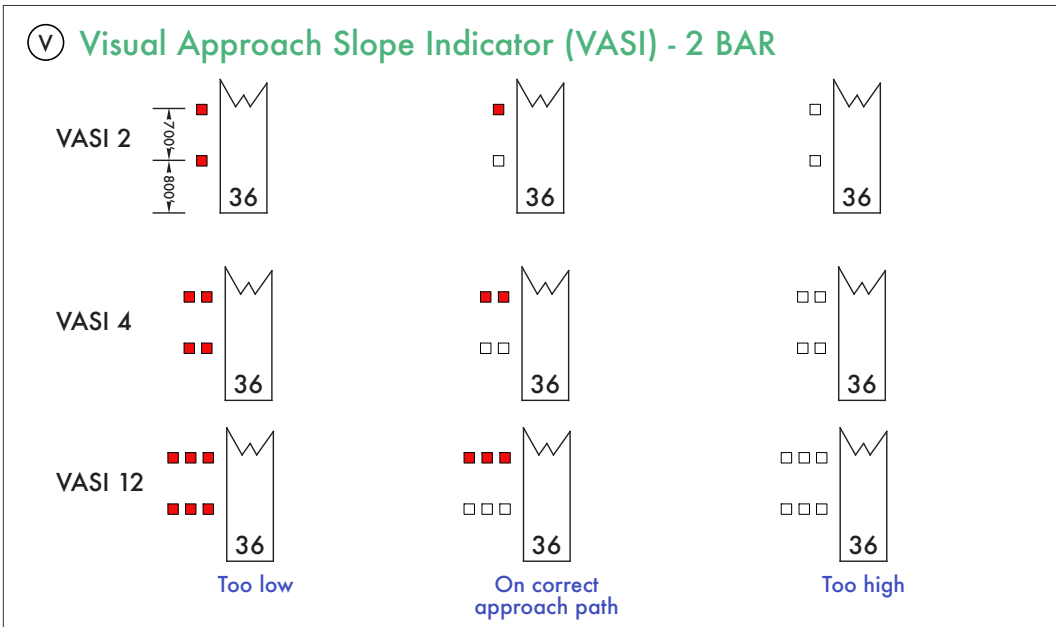
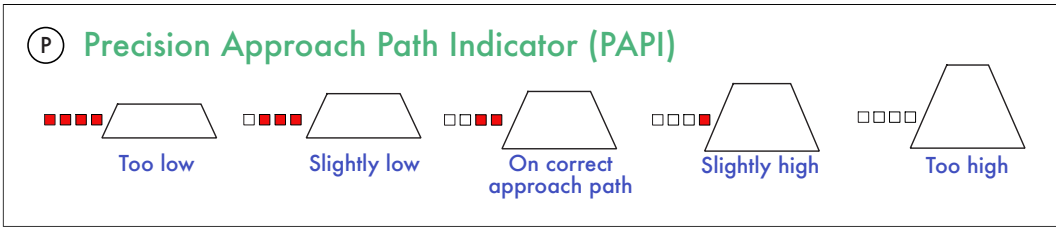

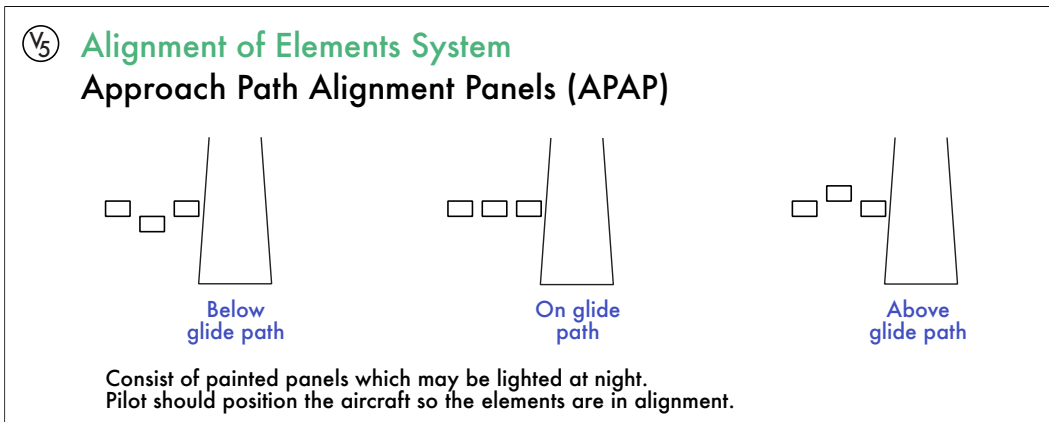
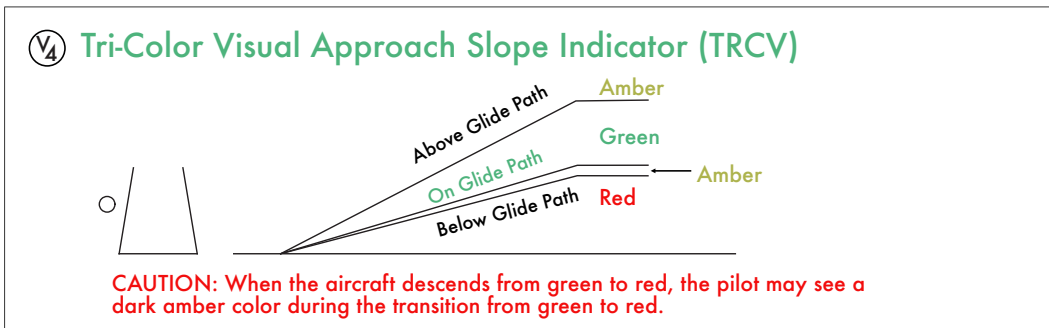
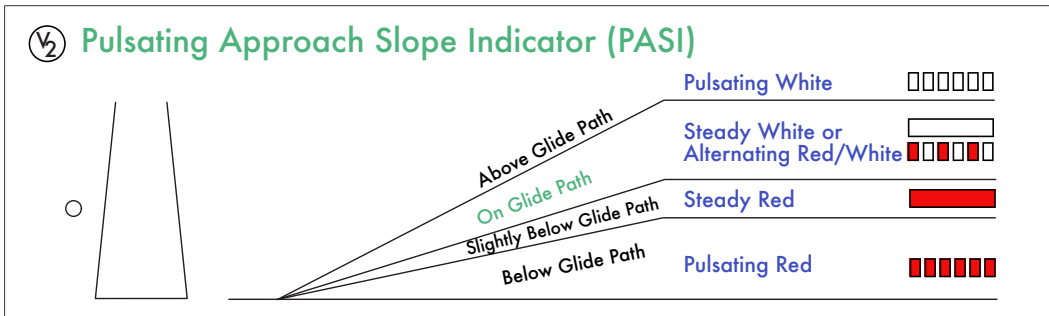

Term	Definition
AATD	Advanced Aviation Training Device
AAWU	Alaskan Aviation Weather Unit
AC	Advisory Circular
ACS	Airman Certification Standards
AD	Airworthiness Directive
ADC	Air Data Computer
ADM	Aeronautical Decision Making
ADS-B	Automatic Dependent Surveillance-Broadcast
AFM	Airplane Flight Manual
AGL	Above Ground Level
AHRS	Attitude Heading Reference System
AI	Attitude Indicator
AIM	Aeronautical Information Manual
ALS	Approach Light System
ALSF	Approach Light System with Sequence Flashing Lights (e.g. ALSF-1, ALSF-2)
APV	Approach with Vertical guidance
ARTCC	Air Route Traffic Control Center ("Center")
ASI	Airspeed Indicator
ASOS	Automated Surface Observation System
ASR	Approach Surveillance Radar
ATC	Air Traffic Control
ATD	Aviation Training Device
ATIS	Automatic Terminal Information Service
AWC	Aviation Weather Center
AWOS	Automated Weather Observation System
BATD	Basic Aviation Training Device
DA	Decision Altitude
DH	Decision Height
DME	Distance Measuring Equipment
DP	Departure Procedure
EDCT	Expect Departure Clearance Time
EFB	Electronic Flight Bag
ELT	Emergency Locator Transmitter
ETA	Estimated Time of Arrival
FAA	Federal Aviation Administration
FAF	Final Approach Fix
FCC	Federal Communications Commission
FFS	Full Flight Simulator
FIS-B	Flight Information Services-Broadcast
FL	Flight Level
fpm	Feet per Minute
FPNM	Feet per Nautical Mile
FSS	Flight Service Station

Term	Definition
FTD	Flight Training Device
GBAS	Ground Based Augmentation System (i.e. LAAS)
GLS	GBAS Landing System
GP	Glide Path
HFO	Weather Forecast Office Honolulu
HI	Heading Indicator
IAF	Initial Approach Fix
ICAO	International Civil Aviation Organization
IF	Intermediate Fix
IFR	Instrument Flight Rules
ILS	Instrument Landing System
IM	Inner Marker
IMC	Instrument Meteorological Conditions
IPC	Instrument Proficiency Check
KTAS	Knots True Airspeed
Kts	Knots. NM / hour.
LAAS	Local Area Augmentation System
LDA	Localizer Type Directional Aid.
LIFR	Low IFR
LNAV	Lateral Navigation
LOC	Localizer
LP	Localizer Performance RNAV / RNP approach
LPV	Localizer Precision with Vertical Guidance approach
MAA	Maximum Authorized Altitude
MALSR	Medium Intensity Approach Lighting System with Runway Alignment Indicator Lights
MAP	Missed Approach Point
MCA	Minimum Crossing Altitude
MDA	Minimum Descent Altitude
MDH	Minimum Descent Height
MEA	Minimum Enroute Altitude
MEL	Minimum Equipment List
MFD	Multi Function Display
MLS	Microwave Landing System
MM	Middle Marker
MOCA	Minimum Obstruction Clearance Altitude
MON	VOR Minimum Operational Network program
MORA	Minimum Off Route Altitude (Jeppesen)
MRA	Minimum Reception Altitude
MSL	Mean Sea Level
MVFR	Marginal VFR
NDB	Non-Directional Beacon

Term	Definition
Night (FAR §1.1)	The time between the end of evening civil twilight and the beginning of morning civil twilight, as published in the Air Almanac, converted to local time.
NHC	National Hurricane Center
NMC	National Meteorological Center
NOTAM	Notice to Air Missions
ODALS	Omni-Directional Approach Lighting System
ODP	Obstacle Departure Procedure
OM	Outer Marker
OPC	Ocean Prediction Center
PAPI	Precision Approach Path Indicator
PAR	Precision Approach Radar
PFD	Primary Flight Display
PIC	Pilot-in-Command
PIREP	Pilot Report
RAIM	Receiver Autonomous Integrity Monitoring
RAIL	Runway Alignment Indicator Lights
REIL	Runway End Identifier Lights
RNAV	Area Navigation
RVR	Runway Visual Range
RVV	Runway Visibility Value
RVSM	Reduced Vertical Separation Minimum
SBAS	Satellite-based Augmentation System (e.g., WAAS, EGNOS)
SDF	Simplified Directional Facility
SID	Standard Instrument Departure
SFRA	Special Flight Rules Area
STAR	Standard Terminal Arrival
STC	Supplemental Type Certificate
SVFR	Special VFR
TCH	Threshold Crossing Height
TDZ	Touchdown Zone
TDZE	Touchdown Zone Elevation
TDZL	Touchdown Zone Lights
TIBS	Telephone Information Briefing Service
TLS	Transponder Landing System
TOC	Top of Climb
TOD	Top of Descent
TWEB	Transcribed Weather Broadcast
UAT	Universal Access Transceiver
VASI	Visual Approach Slope Indicator
VDA	Vertical Descent Angle
VDP	Visual Descent Point
VFR	Visual Flight Rules
VIP	Video Integrator Processor

Term	Definition
VCOA	Visual Climb Over Airport
VMC	Visual Meteorological Conditions
VNAV	Vertical Navigation
VOR	VHF Omnidirectional Range
VORTAC	VHF Omnidirectional Range Tactical Air Navigation (VOR+TACAN)
VS	Vertical Speed
VSI	Vertical Speed Indicator
WAAS	Wide Area Augmentation System
WPC	Weather Prediction Center
Wx	Weather

Check for updates at:

<https://PilotsCafe.com/IFR-quick-review-guide/>



Disclaimer: While every attempt was made to verify the accuracy of the information in this report, the author does not assume any responsibilities or liabilities for errors contained in it or for misuse of this information. You may only use this guide at your own risk.

Please send any error corrections or feedback to: www.PilotsCafe.com/contact

All rights reserved to Amir Fleminger and Fleminger Media LLC dba PilotsCafe®. PilotsCafe® is a USA Registered Trademark. All Rights Reserved.



Introducing our new partner AIROS™ – the intelligent digital logbook designed by pilots for pilots.

Activate your AIROS Membership with an exclusive **20% discount** from PilotsCafe.



AIROS360.com/soar/pilotscafe-20